

# **GR**Reddy®

## ***GR*Reddy Intercooler Kit**

*Toyota Supra TT Front- Mounted Intercooler (JZA80)*



## (2JZ -GTE) Toyota Supra (JZA80) Intercooler Kit 1993-7

# Installation Manual

Please read the entire manual before installing this kit.

### Application:

Make	Model	Chassis	Year
Toyota	Supra	JZA80	93 - 97

- This **GRReddy Front Mount Intercooler Kit** is designed only for vehicles equipped with the factory turbochargers.
- The factory Auto-Spoiler will not function with this intercooler kit installed.

Fig. 1

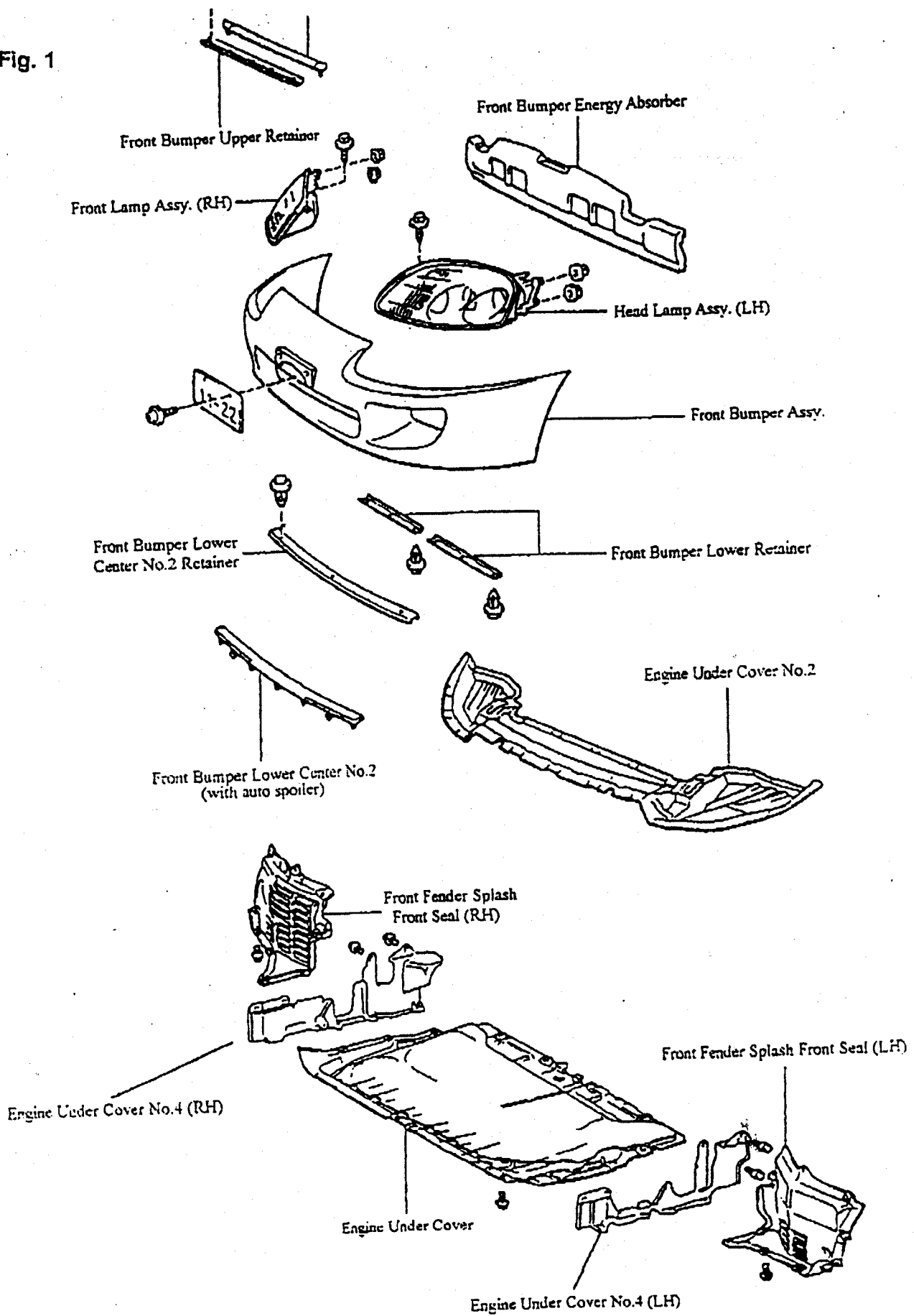

## Factory Intercooler Removal

- 1) Remove the air duct as shown

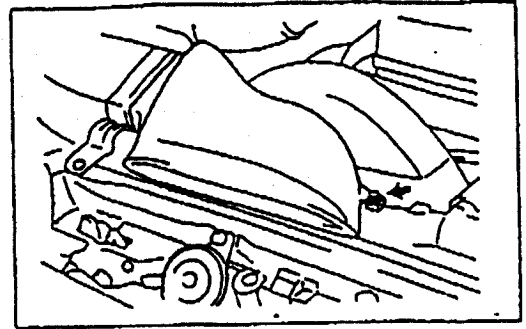

- 2) Remove the air hose No. 1

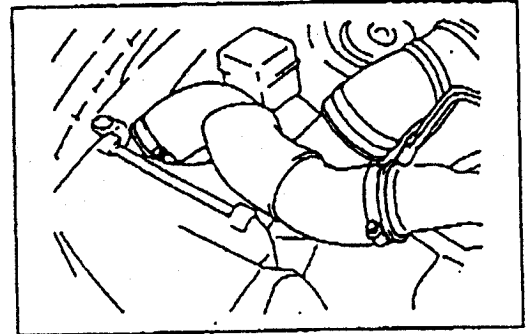

- 3) Remove the air cleaner assembly as shown

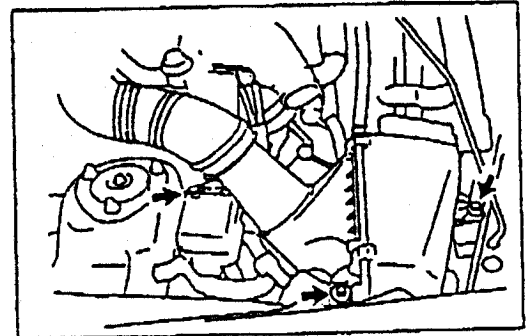

- 4) Remove air hose No. 5

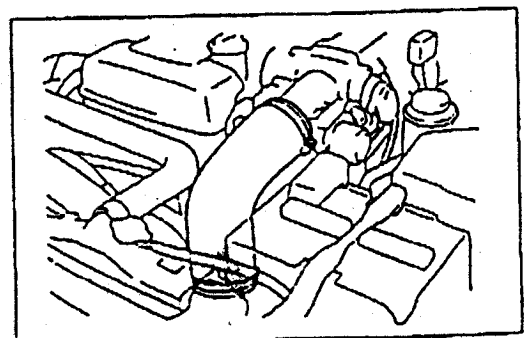

- 5) Remove air pipe No.3 with air hose No.4 .

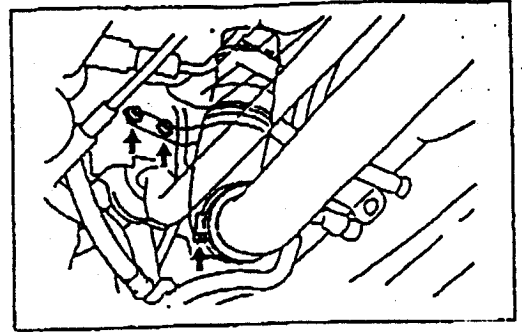

- 6) Remove air pipe No.2

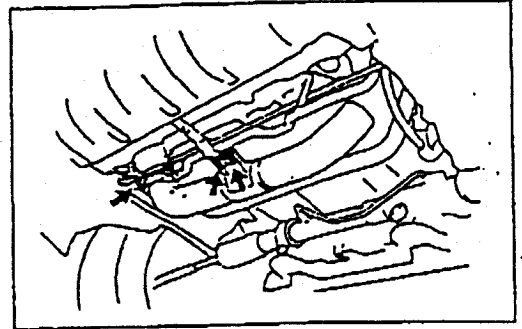

- 7) Remove air hose No.3

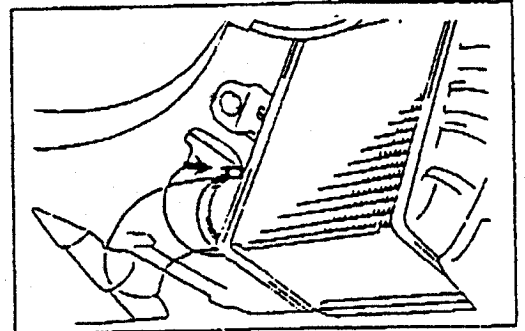

- 8) Remove air hose No.2

- 9) Remove air pipe No.1

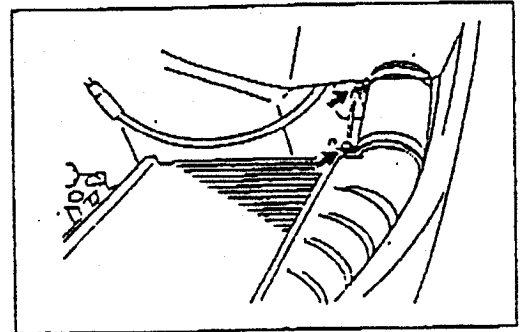

- 10) Remove the factory intercooler.

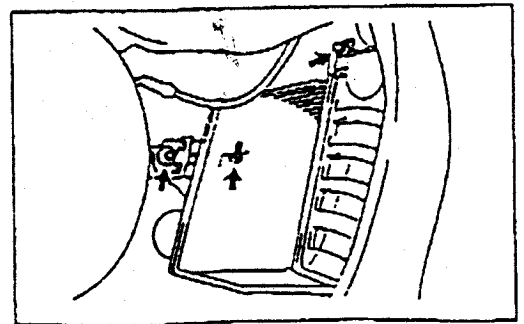

## 2. Stock Parts Removal

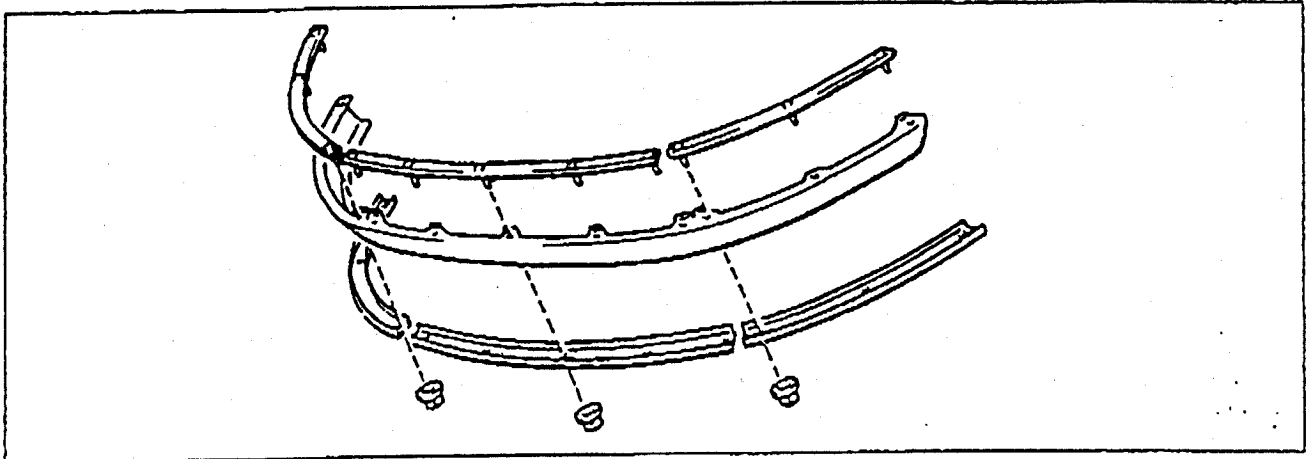

### Front Bumper Assembly Removal

- (1) Remove the (-) neg. terminal of the battery
- (2) Remove the under cover No. 2, by removing 5 bolts, 14 screws and 5 nuts.

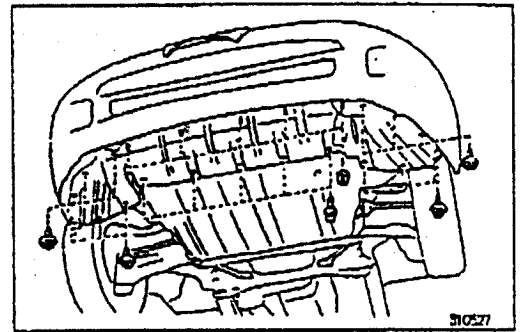

- (3) Remove the left and right splash guards (vehicles with out the auto-spoiler)

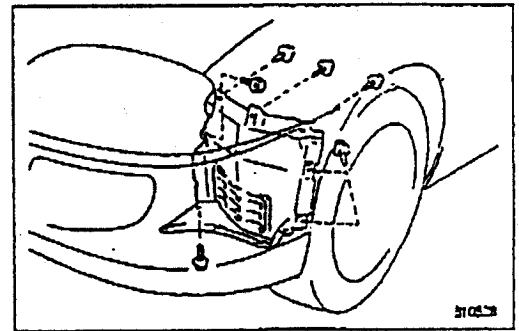

- 1) (For vehicles with the auto-spoiler, remove 10 screws to remove the splash guard)

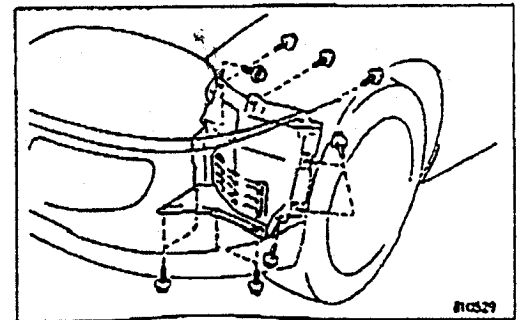

2) Remove the left and right engine under cover No. 4

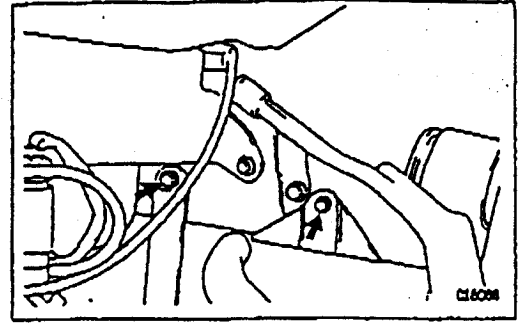

(4) Head light removal

- 1) Remove a bolt and 2 nuts as shown
- 2) Disconnect the head light harness

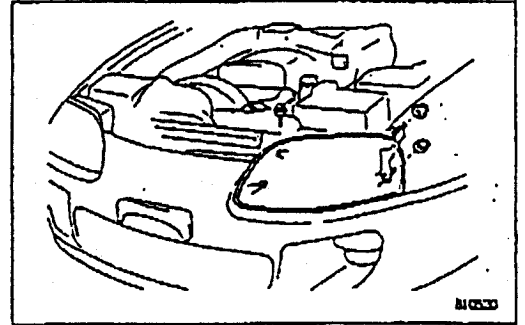

- 3) Pull out the head light assembly

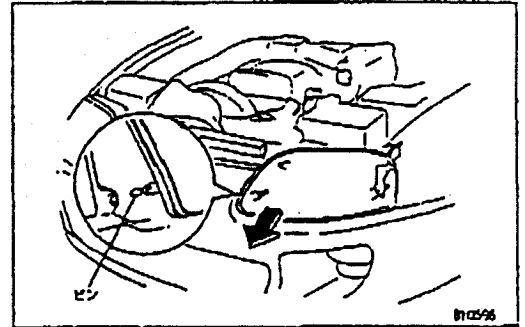

(5) Front bumper cover assembly removal

- 1) Remove the hood front end panel seal.

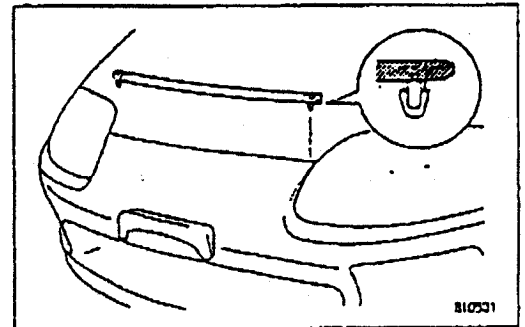

- 2) Remove the upper center retainer.

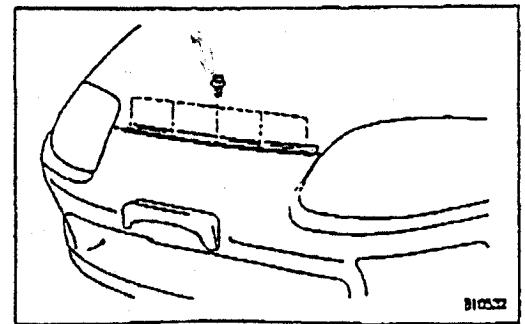

- 3) Remove the lower center retainer

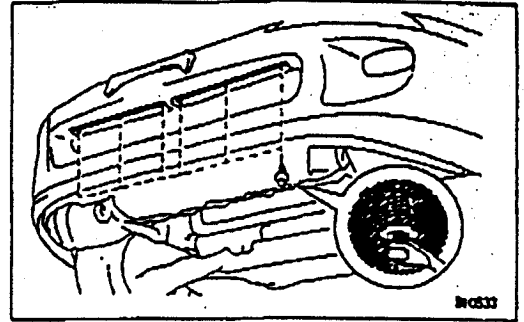

- 4) Remove the lower center retainer No. 2, by removing 2 clips (vehicles with out auto spoiler)

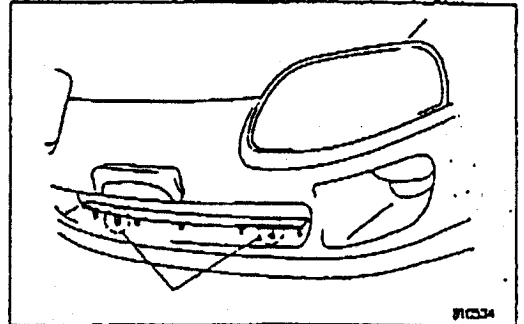

- 5) Remove the lower center retainer No.2, by removing 3 clips. (vehicles with auto spoiler)

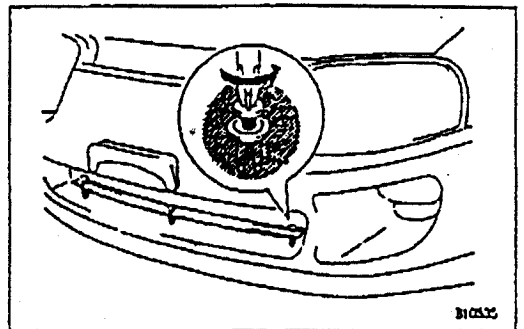

- 6) Remove the 6 bolts securing the bottom of the front bumper cover.

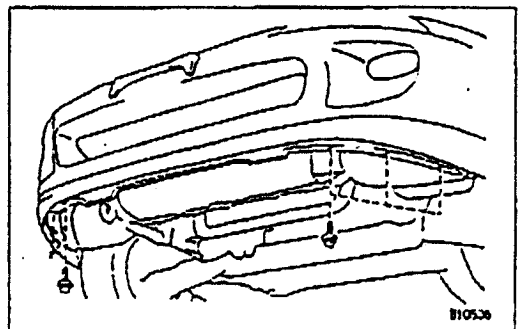

- 7) Remove the 4 nuts on the other side
- 8) Disconnect any remaining harnesses and remove the front bumper cover.

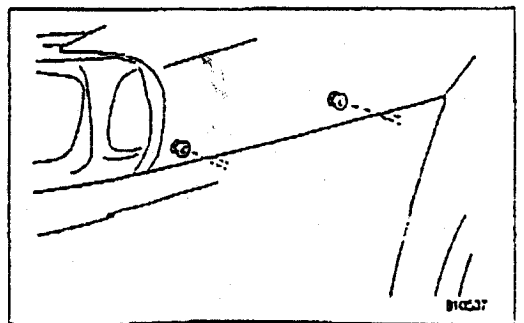
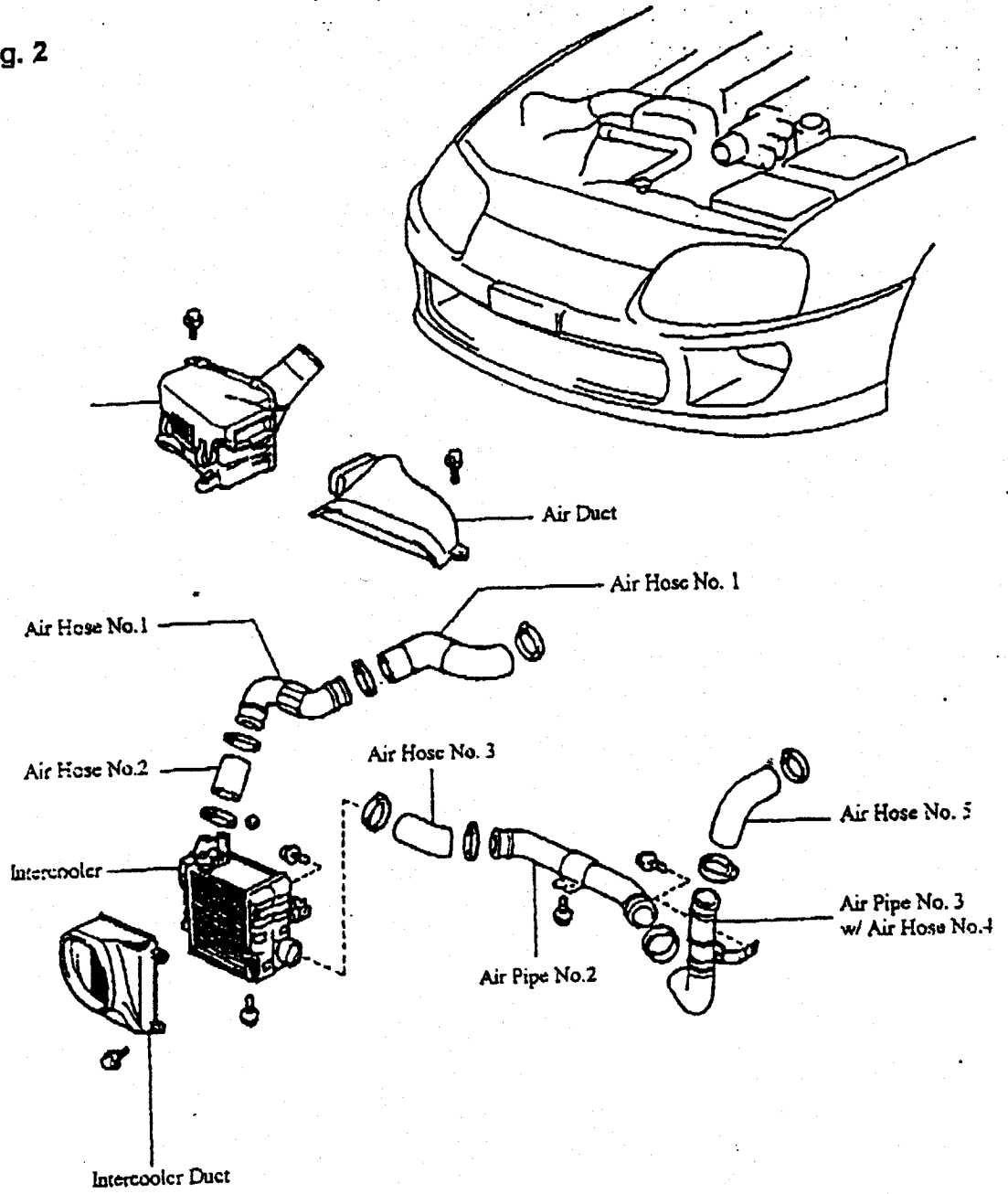

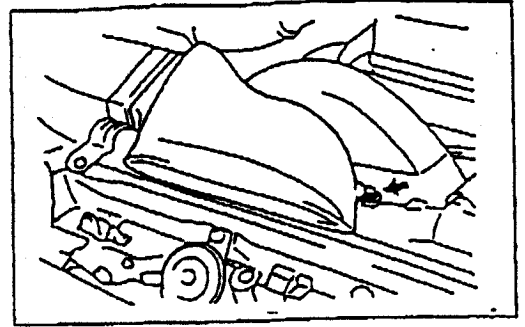

Fig. 2



## Factory Intercooler Removal

- 1) Remove the air duct as shown



- 2) Remove the air hose No. 1

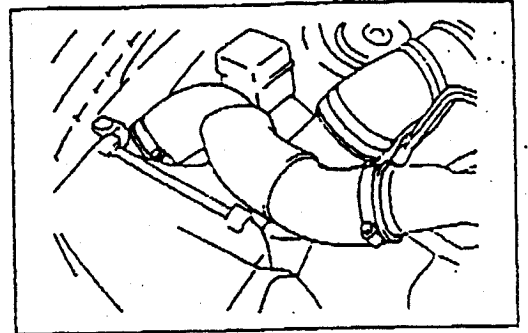

- 3) Remove the air cleaner assembly as shown

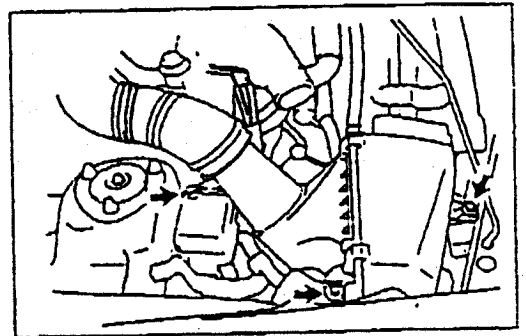

- 4) Remove air hose No. 5

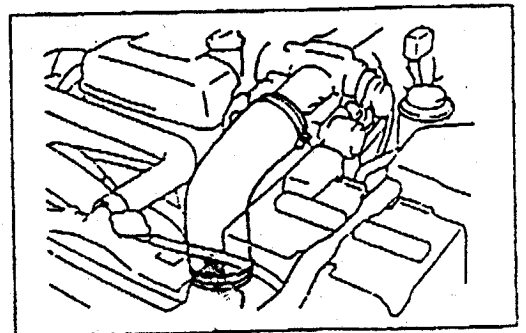

## Remove

- 1) Remove the coolant reservoir tank, hood lock wire, duct cover, and ambient temp sensor.

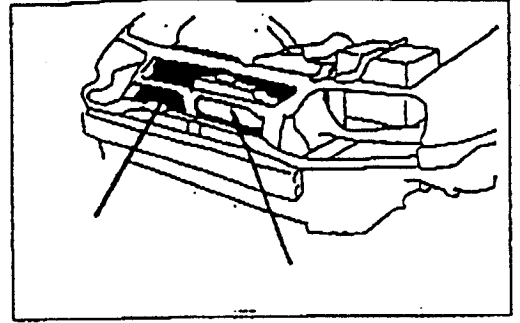

- 2) Drain the power steering fluid. Remove the power steering cooler tube and cap off the power steering hose.

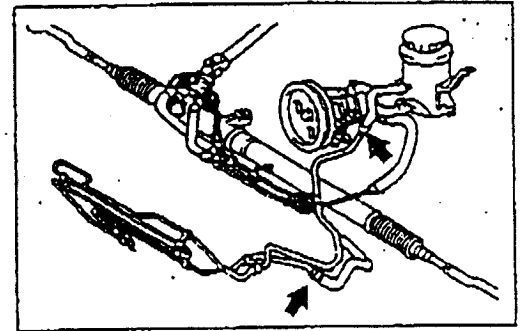

Also refer to the factory owners manual for further help.

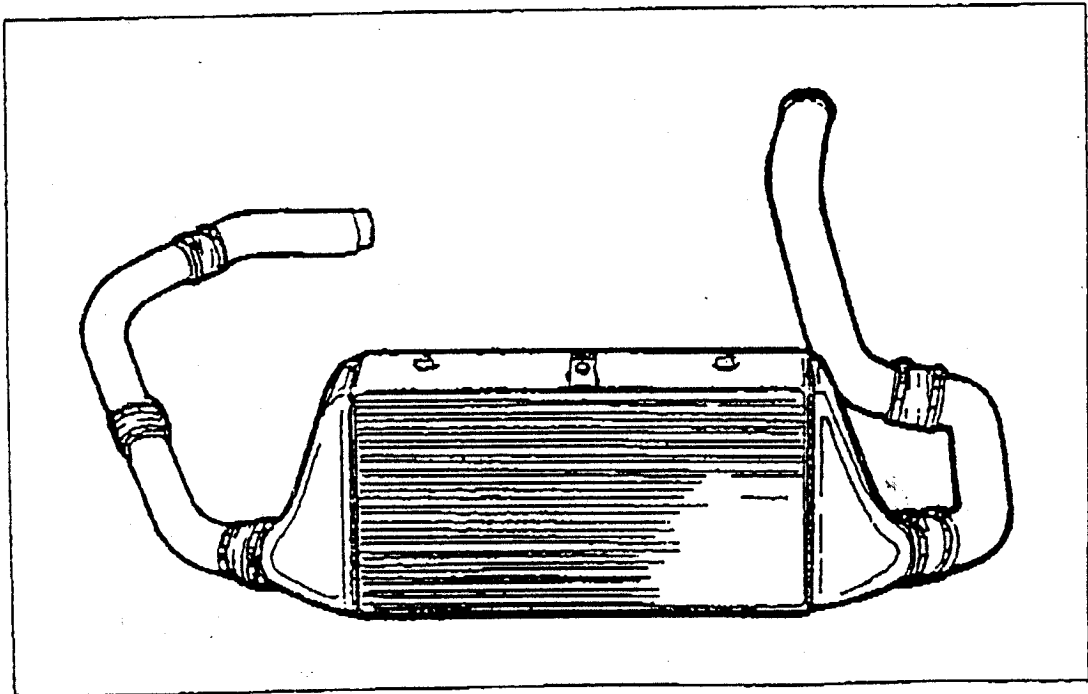

### 3. GReddy Intercooler Kit Installation

#### 3-1 Body Modification

- (1.) Cut the shaded area on the body, as shown in fig. 3. (near the toe hooks).

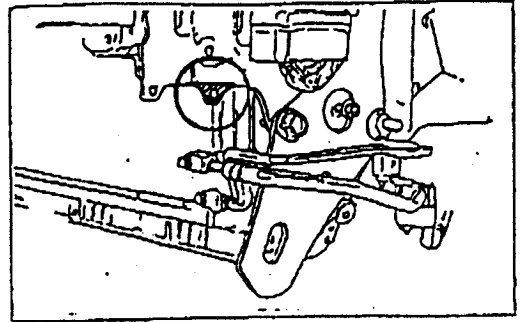

Fig. 3

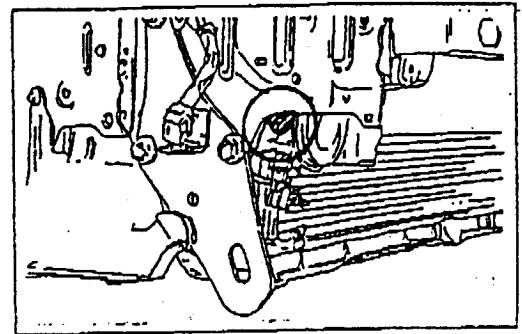

Fig. 4

#### 3-2 Ambient Temp Sensor Installation

- (1.) Remount the ambient sensor with the right horn bracket

(part #25)

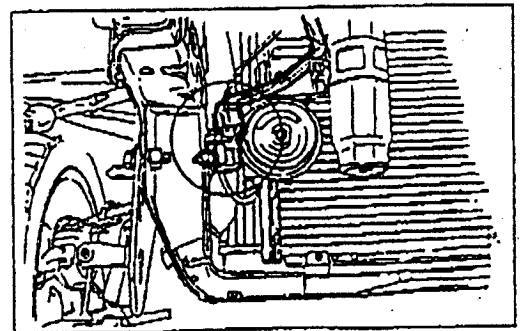

Fig. 5

#### 3-3 Hood Lock Wire Mount

- (1.) Remount the hood lock wire as shown with the provided part #9.

(part # 9, 26, 28)

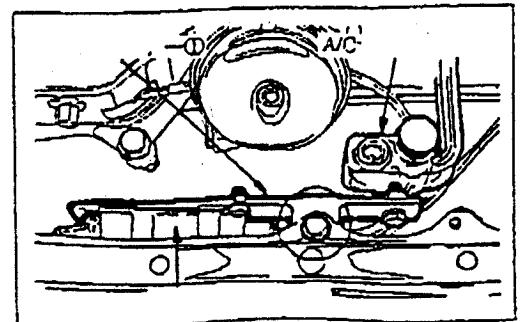

Fig. 6

(2.) Relocate the A/C sight glass onto the bracket you just mounted to the hood lock.

(part # 27)

### 3-4 A/C Tube Relocation

(1.) Relocate the A/C discharge tube using the provided steel bracket #10

(part # 10,27)

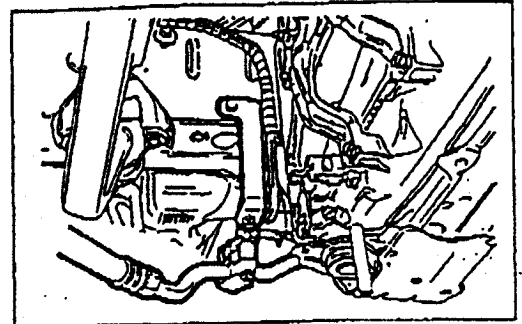

Fig. 7

### 3-5 Intercooler Core Installation

(1) Mount the intercooler using 8mm x 15mm bolts at "A" and the aluminum spacer with the 8mm x 25mm bolt at "B" as shown in Fig. 8

(part # 23, 30, 31)

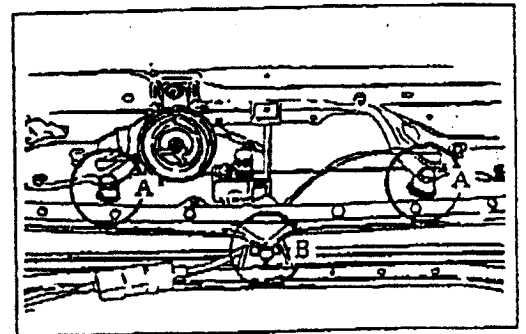

Fig. 8

(2.) Secure the bottom of the intercooler using 6mm bolt as shown.

(part # 27)

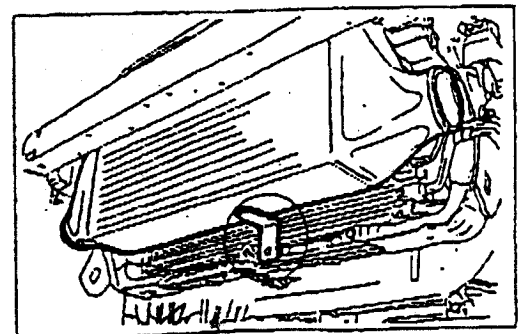

Fig. 9

### 3-6 Air Cleaner Assy Installation

Reinstall the stock air box  
(or Airinx if applicable)

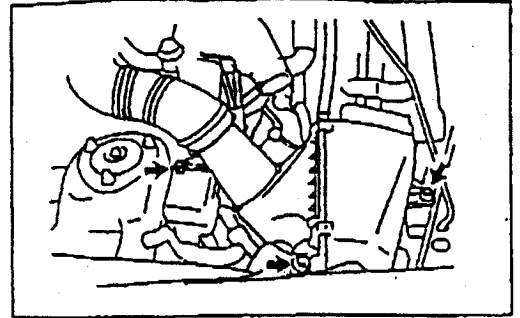

Fig. 10

### 3-7 Installation of the Piping (1)

(1.) Remove the speed sensor harness clip  
"A" that is located in the right front inter fender.

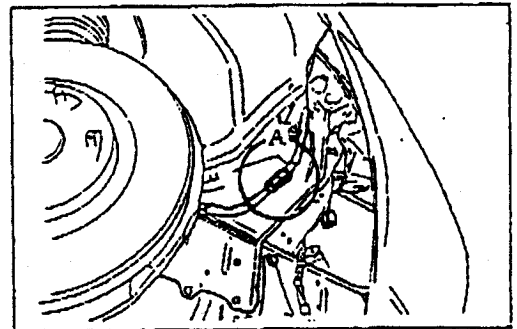

Fig. 11

(2.) Install the intake pipes  
1-1, 1-2, 1-3.

- 1-1 - The 65Ø side goes to the turbo side.
- 1-2 - The longer straight side goes to 1-3
- 1-3 - The shorter side connects the inter-cooler.

(part # 14, 15, 27)

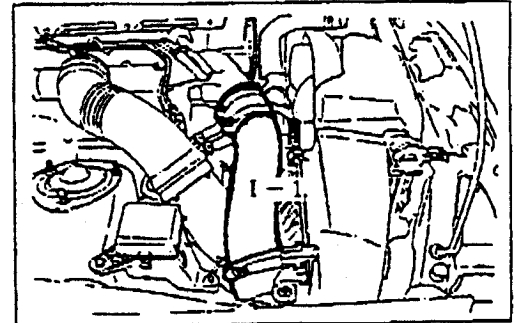

Fig. 12

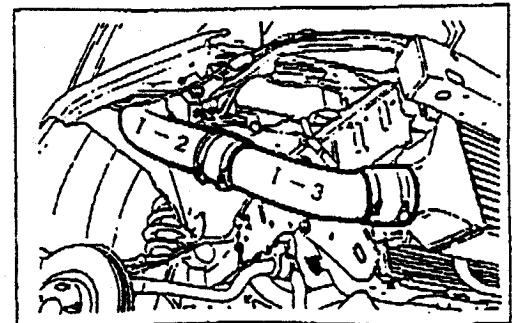

Fig. 13

Route the speed sensor harness in front of the intake pipe I-2 and secure it with tie wraps.

(part #25)

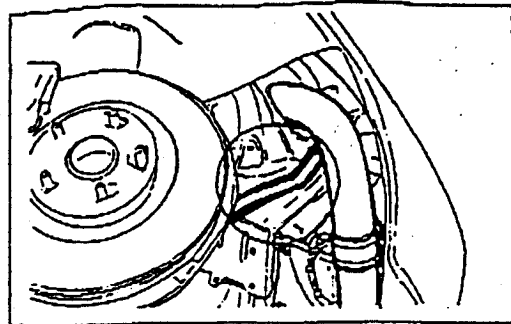

Fig. 14

When clamping the intercooler and charge pipe together, make sure the clamp on the hose band sit on the top side.

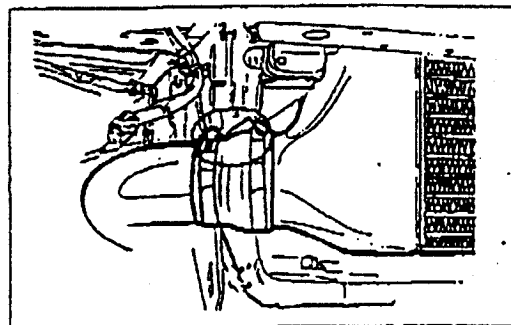

Fig. 15

### 3-8 Installation of the Piping (2)

Install the charge pipe I-4 and I-5 between the intercooler and the throttle.

I-4 The side with 90° bend connects to the intercooler

I-5 The side with less angle on the bend connects to I-4

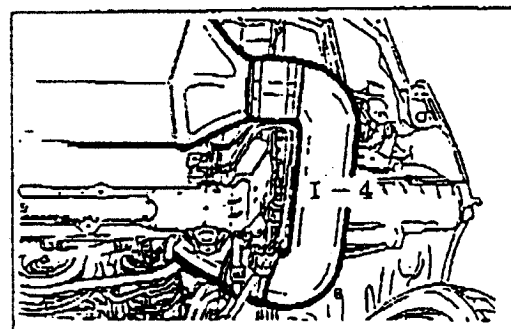

Fig. 16

Use 75Ø rubber spacer and 80Ø rubber hose at the throttle body.

(part # 5, 6, 15, 16, 21)

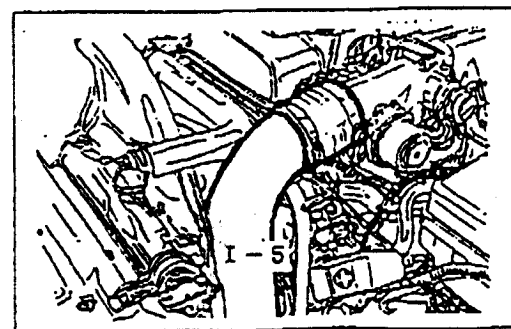

Fig. 17

Position the hose clamp as shown in Fig. 18

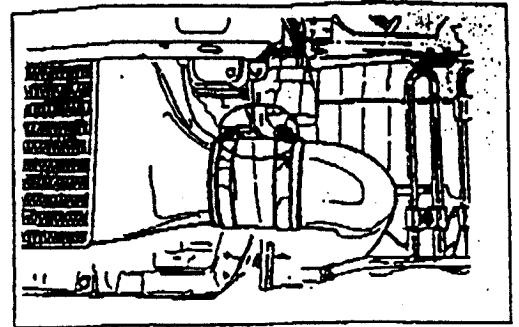

Fig. 18

### 3-9 Installing the Power Steering Cooler

(1) Remove the power steering cooler bracket "A" & "B" and reinstall it onto the power steering cooler.

(part #7)

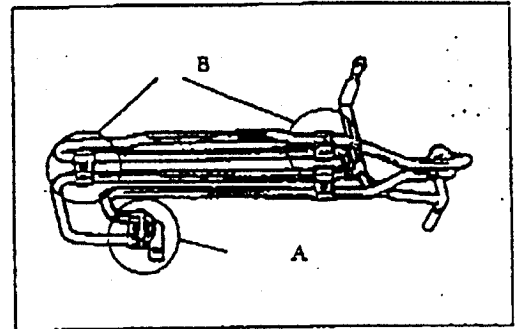

Fig. 19

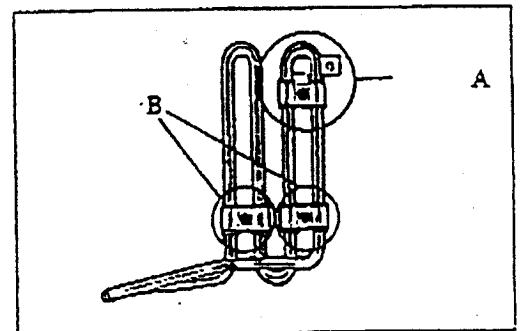

Fig. 20

(2) Using part #11, mount the power steering cooler in front of the washer tank, as shown located in front of the left-front wheel.

(part # 11, 28)

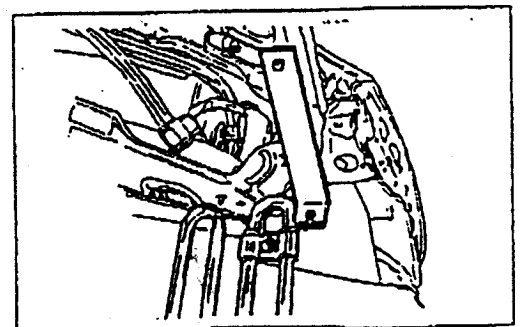

Fig. 21



(3) Connect the power steering gear box to <IN> and the oil fill tank to the <OUT>

(part # 18, 22, 24, 25)

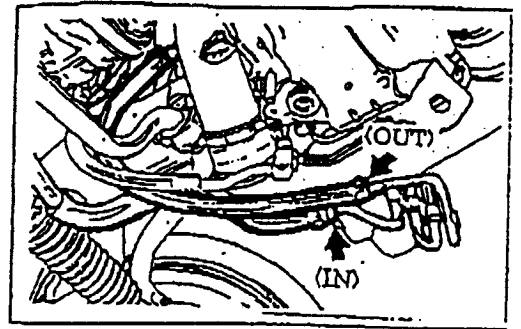

Fig. 22

### 3 -10 Radiator Over Flow Tank Installation

(1) Cut the shaded section of the battery tray as shown in Fig. 23

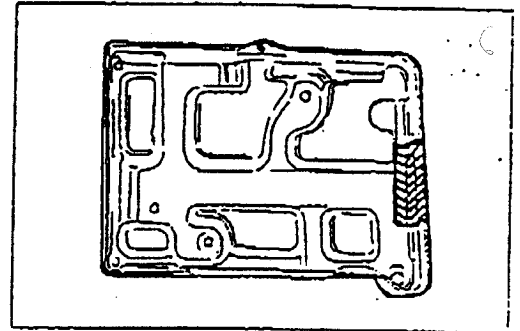

Fig. 23

(2) Mount the coolant tank bracket with the battery tray as shown at point "A" & "B"

(part # 12, 29)

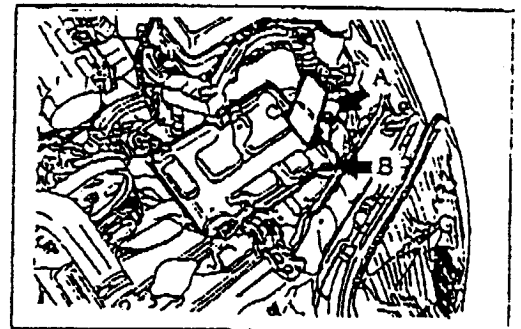

Fig. 24

(3) Install the coolant reservoir tank to the bracket

(4) Connect the hose between the radiator and the reservoir tank.

(part # 8)

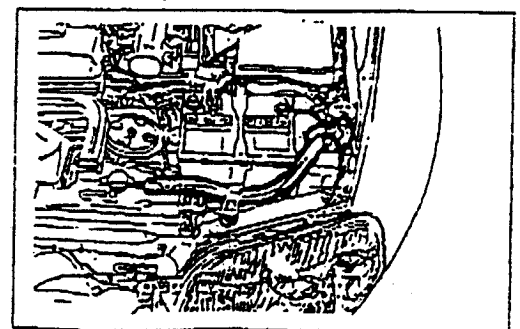

Fig.25

### 3-11 Under Cover Modification

- (1) Cut off the shaded areas on the engine undercovers, Front Fender, Splash Shield for the piping.

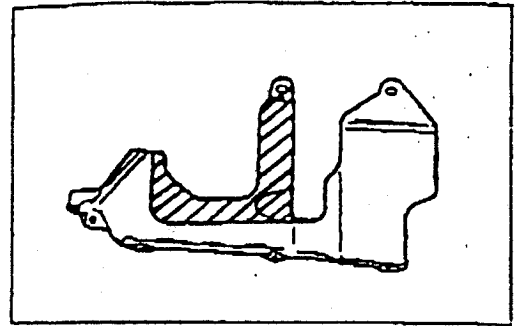

Fig. 26

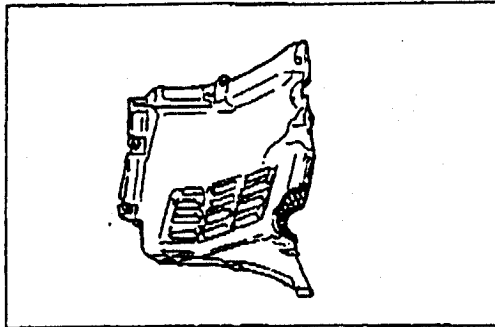

Fig. 27

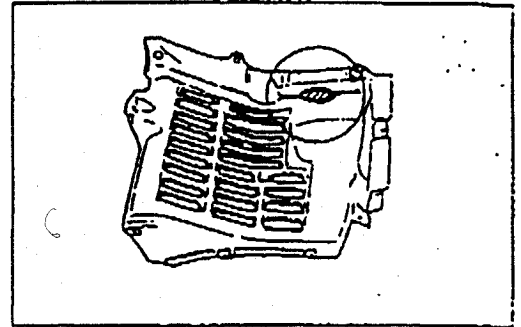

Fig. 28

- (2) Cut the shaded area on the under cover.

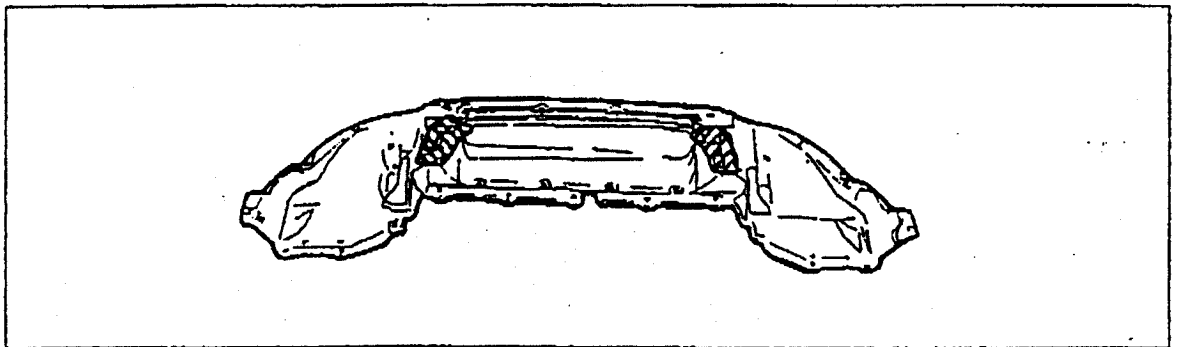

Fig. 29

### 3-12 Engine Start Up

- (1) Check all the harness and piping connections and refill the coolant.
- (2) Install and reconnect the battery
- (3) Refill the power steering fluid and check for any air or oil leaks, at idle.
- (4) Reinstall the engine under covers and the front bumper.