



# Support Tool

GReddy e-Manage Support Tool v1.10

## Instruction Manual

The GReddy logo, featuring the word 'GReddy' in a bold, italicized, sans-serif font.

## 1. Important Information

Please read this instruction manual carefully, and proceed with the installation ONLY if you fully understand this manual. Make sure to pay attention to all the "Important!" "Warning!" and "Caution!" messages through out the manual.

### Important!

- This product is legal for sale or use in California only on vehicles which may never be driven on a public highway.
- This product is only for vehicles with 12V (battery) systems.

### Warning!

- Installation and use of this product should only be performed by a trained specialist, who is very familiar with the automobile's mechanical, electrical, and fuel management systems. If installed by untrained person, it may cause damage to the unit as well as the vehicle.
- When using a soldering iron or other tools for installation, make sure you read and understand the tool's user manual. Mis-use of these tools can cause serious injuries.
- Never tune the E-manage while the vehicle is moving.
- Never tune the e-Manage on public highways. This can be dangerous to you and others on the road.
- When tuning and operating the vehicle in a garage, make sure that the garage is equipped with a proper ventilation system.
- After installation and tuning, make sure to clean up every thing that would interfere the driver. Wires, tools, and laptop computer may interfere with the driver and cause accidents.
- Avoid open sparks, flames, or operation of electrical device near flammable substances.
- Make sure there are no leaks in the fuel system and that all of the connections are secure.

## 1. Important Information

### Caution!

- Improper tuning of the e-Manage can cause damage to the engine.
- GReddy Performance Products, Inc. will not take any responsibility of damage caused by improper installation or tuning.
- Tuning should be performed only by a technician who fully understand the vehicle's fuel management and ignition timing requirement for the engine being tuned.
- Always use a proper air/fuel ratio meter when tuning the e-Manage.
- Installation of this product requires modification of the vehicle's electrical system.
- When making wire connections, be sure to remove the key from the ignition, and disconnect the negative terminal of the battery.
- Never short out the system. It can damage the unit as well as the vehicle's electrical system.
- Read and fully understand the wiring diagram before making any wire connection.
- When connecting the connector, push it in all the way until you hear them click in together.
- The communication cable is not a repairable item, so please take care of it. When disconnecting from the PC (laptop), pull holding the connector. Never pull on the cord.

### Please

- The product and the instruction manual are subject to change without notice.

## 2. Parts List

### Please

- Check the parts list and make sure you have received all the items in the list.



CD ROM x1

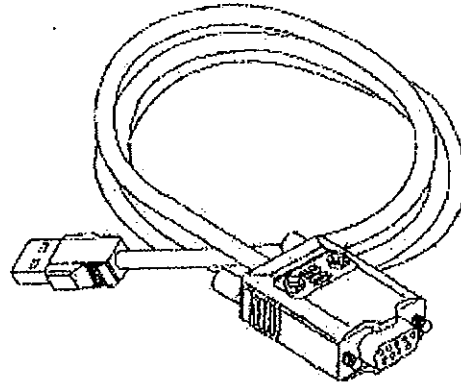

Communication Cable x1

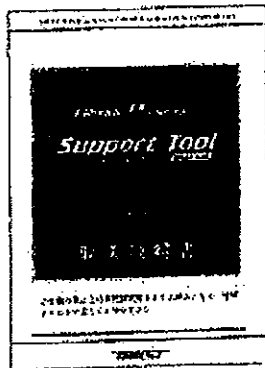

Instruction Manual x1

### 3. Product Features

This product will allow the tuner to program GReddy e-Manage functions, by linking the e-Manage and a Windows® based PC. This product is only for the vehicles equipped with GReddy e-Manage.

#### Features:

- **Air Flow Adjustment Map**  
This 16 x 16 (rpm x throttle position) table is used to fine-tune the input signal of the Air Flow Meter or MAP Sensor to the ECU for fuel enrichment.
- **Upgrade Injectors**  
Controls upgrade injectors. (up to 150% larger than factory)
- **Upgrade Airflow meters**  
Controls upgrade Airflow meters.
- **Boost limiter cut feature**  
Eliminates factory boost limiter.
- **Anti Engine Stall feature**  
This is used to stabilize the rough idle due to turbo compressor surge, Blow-off valve vented out to the atmosphere or use of a high lift camshaft.
- **VTEC® Setting**  
This is used to set the VTEC setting without going in to the Main Unit.
- **Map Trace feature**  
This allows the tuner to pin point the current location on any map table.
- **Real Time Display feature**  
This allows the tuner to monitor the engine condition in real time.
- **Real Time Communication**  
This allows the PC and e-Manage to communicate at real time. Any changes made on the computer screen is sent to e-Manage with in 2-3 sec.
- **Data Logging feature**  
This allows the tuner to view the data recorded and saved during the real-time mode in graph form.
- **Security Setting feature**  
This allows the tuner set up a password to apply a security lock to the data in the main unit.

#### Optional Parts:

- **Harness Kit (Injector control)**  
This harness is used when controlling main injectors or sub injectors
- **Harness Kit (Ignition Timing Control)**  
This Harness is used when controlling the ignition timing.
- **GReddy Pressure Sensor**  
GReddy pressure sensor can be used for the scale of each Map table. This is used when the factory system exceeds the Air Flow Meter or MAP sensor capacity.

## 4. Before Installation

Before installation of the software, please make sure that the PC is set up correctly. This product will only operate on Windows®95, 98, Me, or 2000, that meets the requirements listed below.

### System Requirements

- Intel® Pentium® 166MHz or faster processor
- At least 32MB of RAM (64MB recommended)
- A hard drive with at least 50MB of free space.
- A SVGA monitor (800x600) and a 16bit (high color) display
- A 3.5inch 1.44MB floppy disk drive
- A CD-ROM drive
- Serial port with RS-232C D-Sub 9 pin connector (male)

### Important

- If the Serial port is not D-Sub 9 pin connector (male), an adapter will be necessary to connect the communication cable.
- For computers that are not equipped with a Serial port, a USB to Serial adapter is required. Do not use USB to USB cable.

If your computer meets the requirement listed above, the basic features of this program will operate, but to use the "Real Time Monitor" feature requires the following.

### Required to use the "Real Time Monitor"

- Intel® Pentium® II® 266MHz or faster processor
- At least 128MB of random-access memory (RAM)

As for the setup and installation of the Windows®, please refer to the "Getting Started" manual included in the Windows® Software.

## 4. Before Installation

### Basic PC Operation

This system will basically operate the same as any other Windows® based software, such as changing window size, closing window, mouse operation, quitting, and etc. For further information, please refer to the "Getting Started" manual included with the Windows® Software.

### Please Note

- The Support Tool v1.10 software has a Main Unit (e-Manage) Update v1.20 program that will automatically detect and update an old version unit when the Main Unit is linked with the PC.

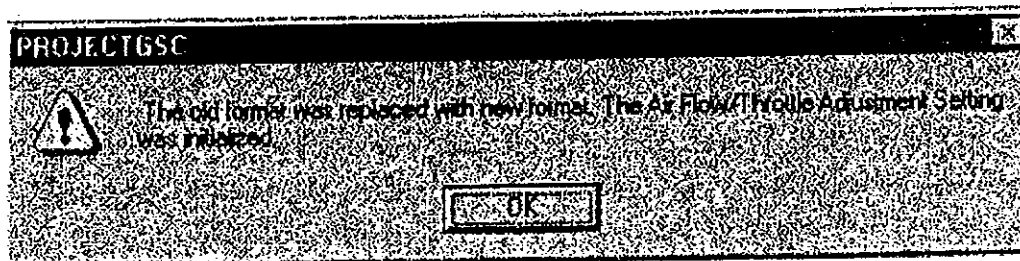
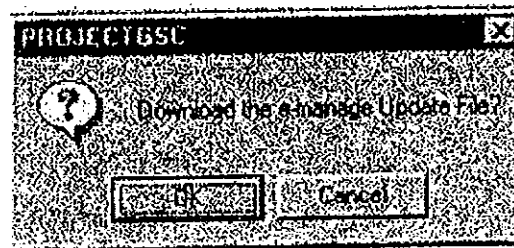

## 5. Software Installation

Follow the instructions listed below to install the Support Tool software.

### Software Installation

1. Turn Personal Computer "ON"
2. Insert the Support Tool CD-ROM in the CD-ROM drive. This software is a self installing software, so installation will begin soon as the CD-ROM is inserted. Follow the instruction on the screen.
3. After the installation is complete, GReddy e-Manage short cut icon will appear on the desktop.

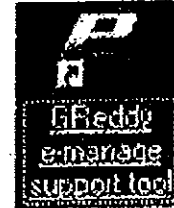

### Important

- If the self installation fails  
Depending on the computer's settings, it will not allow self installation. When this happens, double click the "setup.exe" in the "DISK1" folder in the CD-ROM to install the software.
- If the program does not operate properly  
Uninstall the program, and reinstall the program.
- If communication feature does not operate  
Uninstall the program, and reinstall the program.

### To uninstall

1. Click on the "ADD/REMOVE PROGRAM" in the "CONTROL PANEL".
2. From "ADD/REMOVE PROGRAM" list, select "GReddy e-Manage Support Tool", then click on "ADD / REMOVE" button.
3. Click "OK"
4. When it return to the "ADD/REMOVE PROGRAM" window click "OK" to go back to "CONTROL PANEL".
5. Close the "CONTROL PANEL" window.



## 6. Wire Diagram Information

### Wire diagram for Injector Signal

- Please read the instructions included with the Injector Harness kit, and proceed with the wiring only if you fully understand the instructions.
- Connect to the vehicle's Injector signal wires. Refer to the "Vehicle Specific ECU wire location chart" at the end of this manual for the proper location of each wire. Make sure that you connect same number of wires as the engine's cylinder number. (Excludes Rotary engines)
- For Rotary engines, you can only wire the primary or secondary injector signal or both.

Example 1 For BNR32

- ⊞ Male connector
- ⊟ Female connector
- ⊢ Splice

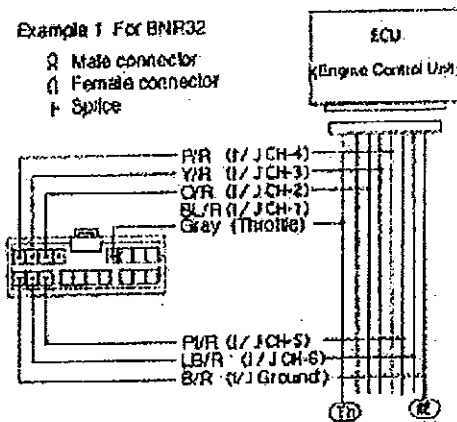

Example 2 For JZ290

(6 cylinder engine with 3 injector signal wire)

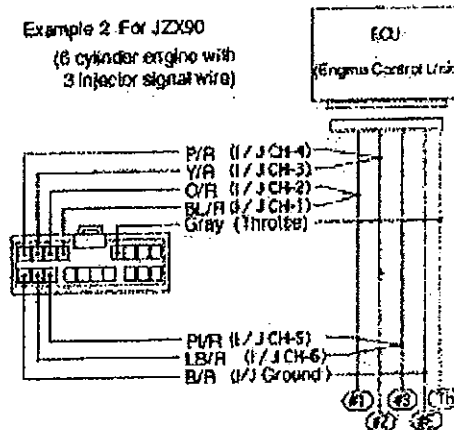

Example 3 For SW20

- ⊞ Male connector
- ⊟ Female connector
- ⊢ Splice

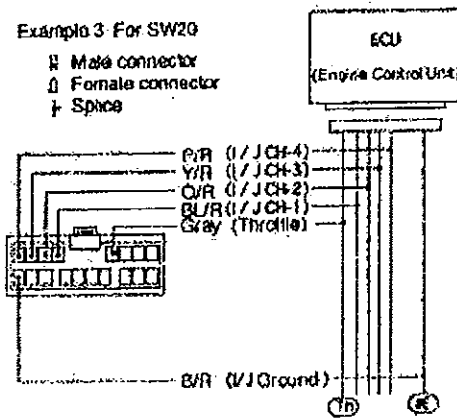

Example 4 For NA6CE

(6 cylinder engine with 3 injector signal wire)

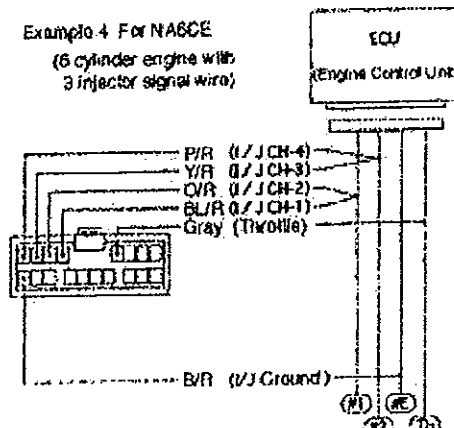

P/R - Purple/Red    Y/R - Yellow/Red    O/R - Orange/Red    BL/R - Blue/Red  
P/R - Pink/Red    LB/R - Light Blue/Red    B/R - Black/Red

### Important

- If the vehicle does not have the same number of injector signal wire as the number of the engine's cylinder number, group 2 wires in to one. See the diagram above.

## 6. Wire Diagram Information

### Wire diagram for Sub Injector Signal

- When using the I/J CH-A, I/J CH-B for sub injectors, set the jumper JP5 and JP6 in the e-manage main unit to "1-2" from "Open".

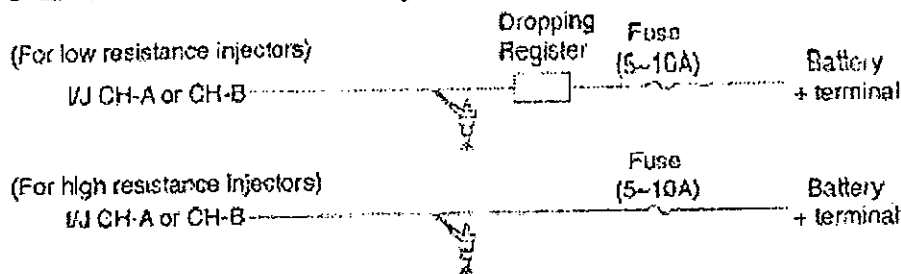

### Important

- If the vehicle does not have the same number of injector signal wire as the number of the engine's cylinders, group 2 wires in to one.

### Wire diagram for Ignition Signal

- Please read the instructions included with the Ignition Harness Kit, and proceed with the wiring only if you fully understand the instructions.
- Connect to the vehicle's ignition signal wires. Refer to the "ECU wire location chart" in this manual for the proper location of each wire.
- Connect the ignition channel wire in the engine's firing order.

e-manage I/G Channel	CH-1	CH-2	CH-3	CH-4	CH-5	CH-6
3, 4, 6, 8 cylinder distributor	t					
Inline 4 cylinder group ignition	t1,4	t2,3				
Horizontally opposed 4 cylinder	t1,2	t3,4				
Inline 4 cylinder individual ignition	t1	t3	t4	t2		
Horizontally opposed 4 cylinder	t1	t3	t2	t4		
Inline 6 cylinder group ignition	t1,6	t5,2	t3,4			
V6 group ignition	t1,4	t2,5	t3,6			
Inline 6 cylinder individual ignition	t1	t5	t3	t6	t2	t4
V6 Individual ignition	t1	t2	t3	t4	t5	t6
13B (FC3S, JC3SE)	tT	tL				
20B (ICESE)	tT			tL		
13B (FD3S)	tT1	tT2	tL			

### Important

- Make sure that wires are connected in the firing order and jumper setting is correct. Improper wiring and setting can damage the ignition coil.

# 6. Wire Diagram Information

Example 1: BNR32  
(In-line 6cyl. individual ignition)

- ♂ Male connector
- ♀ Female connector
- ⊕ Splice

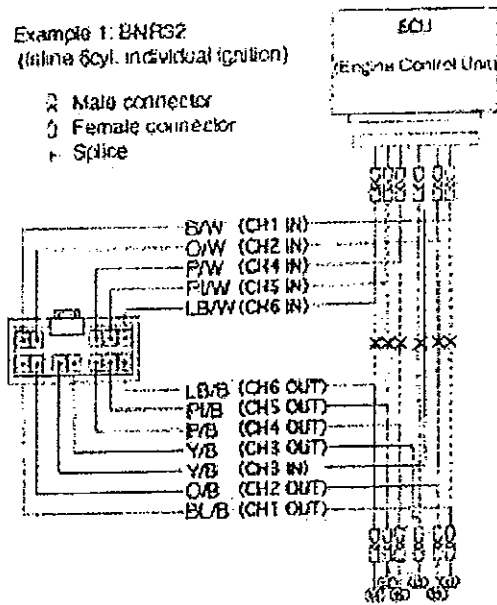

Example 2: NA60E  
(4cyl. group ignition)

- ♂ Male connector
- ♀ Female connector
- ⊕ Splice

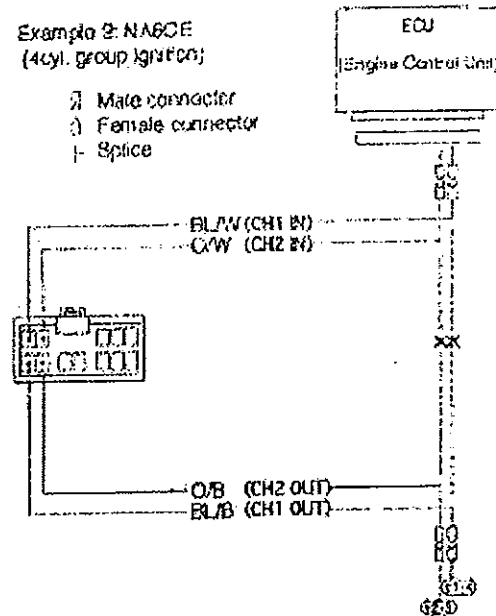

Example 3: EG6

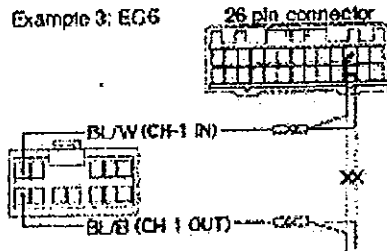

Example 2: AE111  
(Distributor ignition)

- ♂ Male connector
- ♀ Female connector
- ⊕ Splice

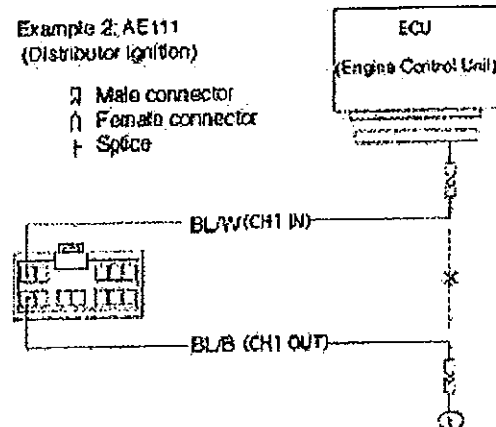

\* On Honda EG type vehicles, the bottom third pin from the right on the 26 pin is also an ignition signal. Group the 2 wire together.

## Important

- On Honda, set the jumper pins JP 1 and JP2 to 2-3.
- After wiring, if the tachometer, or not firing occurs, set the jumper pin JP2 to 2-3. (especially on Toyotas)

## 7. Before you begin

### Starting the application

1. With the IG key in "OFF" position, connect the the PC, and e-Manage using the Communication Cable. D-Sub 9pin connector to PC and USB to the e-Manage.
2. Turn the IG key to the "ON" position, then double click on the e-Manage short cut icon on the desktop.
3. When the application opens, you see the following.

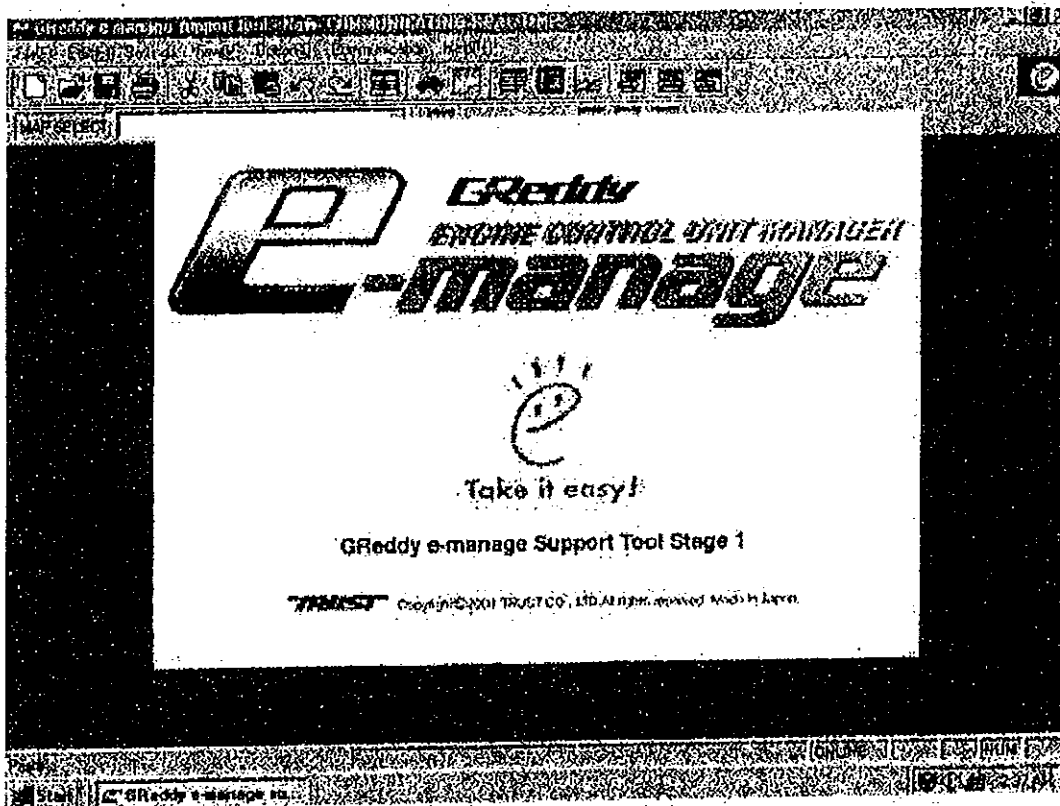

### Please

- Use only the provided communication cable. If a different cable is used, it might damage the PC or/and the e-Manage.

### Download the communication Program (Main Unit Update)

1. Always disconnect the 12 pin connector on the main unit.
2. Check and make sure that the status bar is displaying "ONLINE". If it does not show "ONLINE", Check the COM port setting.

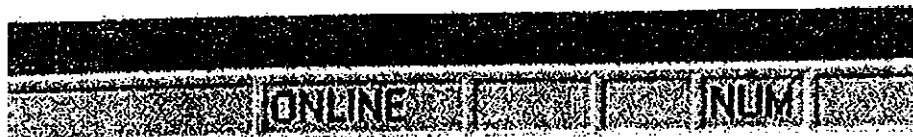

## 7. Before you begin

- The program will automatically detect a unit with old system program. When the update window shows up on the screen,, click "OK" to start downloading the update. Download will take about 2 min.

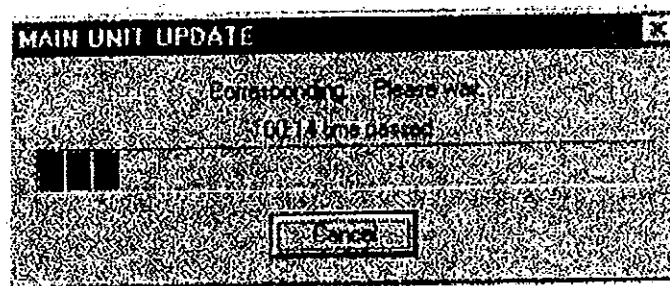
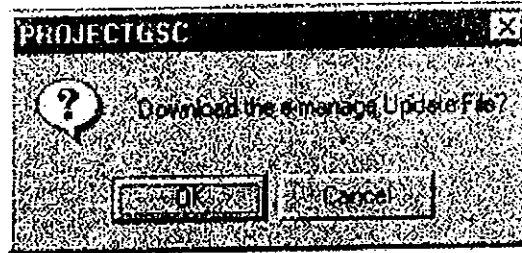

### Please

- Do not disconnect the communication cable during the communication. PC and the e-Manager will not function properly.

- When the updating is complete, the following window will pop up. Turn the IG key to "OFF" position and click "OK".

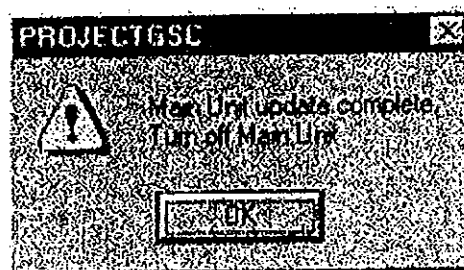

### Important

- The updated program will confirm once the unit is turned "OFF".
- When the unit is turned back "ON", the following message will come up. "The data in the Main Unit was lost! Please export data." this shows that the unit was properly updated.

- This completes the update of the communication program. If the 12 pin connector was disconnected, please reconnect it back.

# 8. Main Unit Setting Information Confirmation



## Main Unit Setting Information Confirmation

1. Turn the IG key to "ON" position and check to make sure that the status bar is displaying "ONLINE". If it does not show "ONLINE", Check the COM port setting.
  2. To confirm the Main Unit Setting Information, select the "Main Unit Setting Information" in the "Setting" or click on the "Main Unit Setting Information" icon.
- \*Changes can not be made in this window.

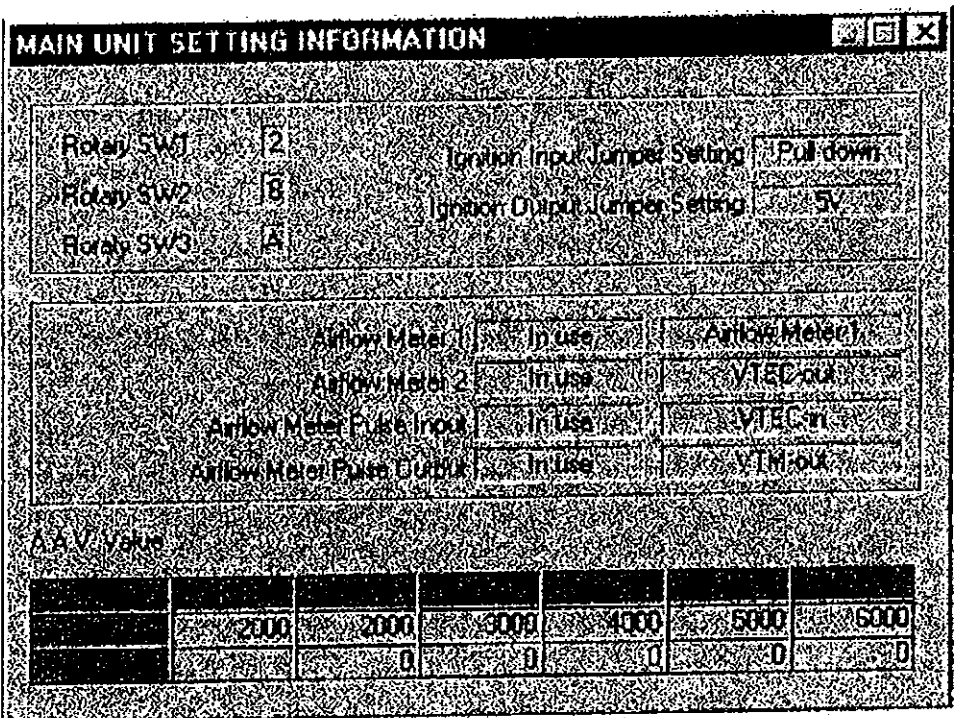

- For the Rotary switches 1-3 setting information please refer to the e-Manage manual.
- For the Ignition Ignition Input Jumper Setting, refer to the "Wire diagram for Ignition Harness" on page \_\_\_\_\_.
- Air Flow Meter 1 -----Used for Hot wire, flap type airflow meters, or MAP sensors
- Air Flow Meter 2 -----Used for GTR(Skyline), or VTEC
- Airflow Meter Pulse Input- --Used for Karman type airflow meters or VTEC
- Airflow Meter Pulse Output - Used for Karman type airflow meters or VTEC
- A.A.V. Value ----- Displays the Main Unit's AAV settings.

## 9. Parameter Setting



### Parameter Setting

This window allows you to change Airflow Meters, Injectors, set the Throttle, and select which map to use.

- To read the program in the Main Unit, select the "Import Data" in the "Communication" menu bar or click on the "Import Data" icon.



- To show the Parameter Setting, select the "Parameter Setting" in the "Settings" menu bar or click on the "Parameter Setting" icon.



**PARAMETER SETTING** [Icons]

Memo:

Air Flow Meter Change:  [v]

GHSensor Pressure Sensor       Absolute Pressure Change

**A/V / RPM Setup**

	Start Point	Point 1	Point 2	Point 3	Point 4	Point 5	
rpm	2000	2000	3000	4000	5000	6000	100rpm

**Injector Change**

cc       cc     

Injector Size Before / Injector Size After \* Correction Factor

**Map Select**

Ignition Timing Adjustment Map

Additional Injection Map      Engine Model:  [v]

Sub Injector Map

VTEC Setting       Boost Limiter C/L Setting

Air Flow Adjustment Map       Anti Engine Stall Setting

Throttle Setting:

[Commit] [Cancel]

## 9. Parameter Setting

### Parameter Setting

#### Air Flow Meter Change

- When the Airflow meter or MAP sensor is upgraded, check the Sensor Type from the "Vehicle Specific ECU wire location chart", and select it from the pull down menu.
- The Airflow Type programmed with the Main unit's rotary switch will display as "Main Unit Setting" in the pull down menu.
- \* When the airflow meter is upgraded, the airflow signal value will change. Make sure to check Air/Fuel Ratio with a proper equipment to ensure proper fuel mixture.

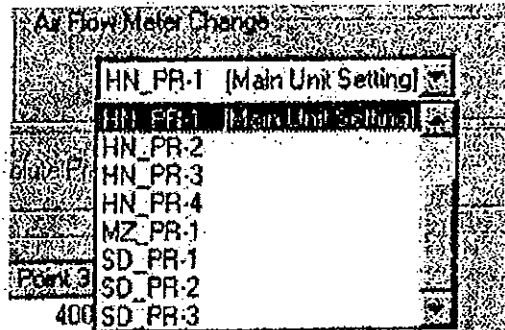

#### GReddy Pressure Sensor

- Choose this box when an optional GReddy pressure sensor will be used for the scale of each Map tables.
- This function is used when the system exceeds the Air Flow Meter's capacity. The factory ECU will continue to read off the Air Flow Meter, but the e-Manage system will work off the GReddy pressure sensor.
- In the Sub Injector Map, the injectors can be controlled by rpm and the GReddy pressure sensor signal.

#### Absolute Pressure Sensor Change

- This function is used when the system exceeds the factory MAP Sensor capacity. The factory ECU will continue to read off the factory MAP sensor, but the e-Manage system will use the calculated absolute pressure from the factory and GReddy pressure sensor.
- \* Use Absolute Pressure Sensor when setting the vacuum as "0" value.
- \* Use Relative Pressure Sensor when setting atmospheric pressure as "0" value.



## 9. Parameter Setting

### A.A.V. RPM Setup

- The rpm points of the AIR FLOW ADJUST VOL. (A.A.V.) on the front panel of the Main Unit can be changed in this window.  
(From 0-10000rpm in 100rpm increments)
- If you set the start Point=Point 1, the value in the rpm below Point 1 will be set to the Point 1 value.
- This is used when you do not need the air flow adjustment during idle.

(Example 1) Factory setting is set to Start Point=Point 1

Adjustment

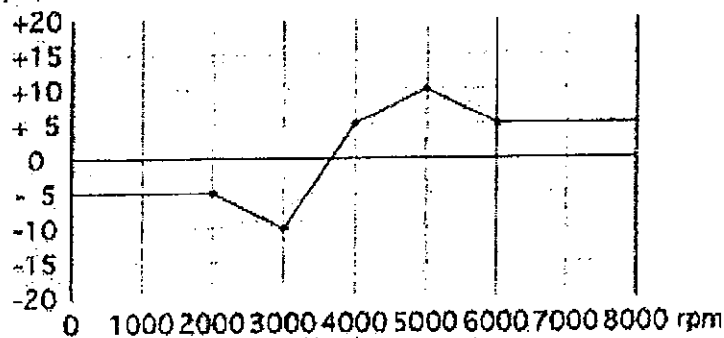

Start Point = Point 1

A.A.V. RPM Setup						
rpm	Start Point	Point 1	Point 2	Point 3	Point 4	Point 5
	2000	2000	3000	4000	5000	6000

(Example 2) Set the Start Point to 1000rpm, to start the adjustment at 1000rpm.

Adjustment

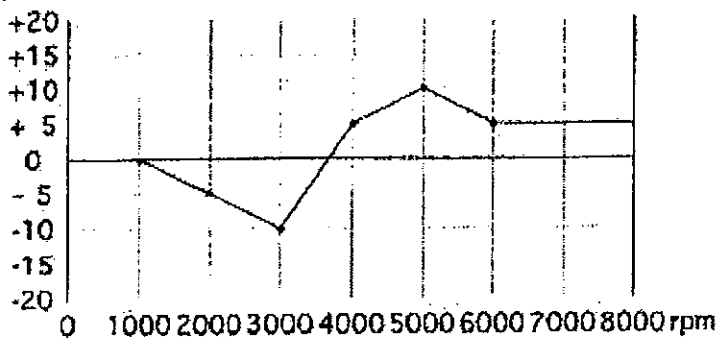

Start Point Point 1

A.A.V. RPM Setup						
rpm	Start Point	Point 1	Point 2	Point 3	Point 4	Point 5
	1000	2000	3000	4000	5000	6000

## 9. Parameter Setting

### Injector Change

- When upgrading the injectors, this feature calculates the difference of the two sizes and trims the whole fuel map (factory map) for proper idling and drivability.
- Input the factory injector size and the upgrade injector size.
- This system can control up to 150% larger injectors than the factory. Too large of an injectors can cause problems performing properly.
- \* When the injectors are upgraded, the injector signal value is being altered. Make sure to check the Air/Fuel Ratio with a proper equipment to ensure proper fuel mixture

Injector Change

240    310    0.774

Injector Size Before    Injector Size After    Correction Factor

### Map Select

- Place check marks on the features you need to program.
- \* On certain applications, you will need to select the proper engine type from the Engine Model pull down menu next to the Additional Injection Map. This sets the system up for the proper numbers of cylinders, and sensors being used. If it does not allow you to make a selection, skip this step. This means that the system already has the proper setting.

Map Select

Ignition Timing Adjustment Map

Additional Injection Map    Engine Model: H22A

Sub Injector Map

VTED Setting     Boost Limits Cut Setting

Air Flow Adjustment Map     Full Engine Pul Setting

Throttle Setting

Confirm    Cancel

## 9. Parameter Setting

### Throttle Setting

- Click on the "Throttle Setting" button on the bottom left corner, to calibrate the throttle position signal. Follow the procedure on the screen.
- \* If the Throttle Setting is not properly programmed, the Anti Engine Stall and Air Flow Adjustment Map will not function properly.
- \* When performing the Throttle Setting, make sure that the IG key is turned to the "ON" position. (engine should be "OFF")

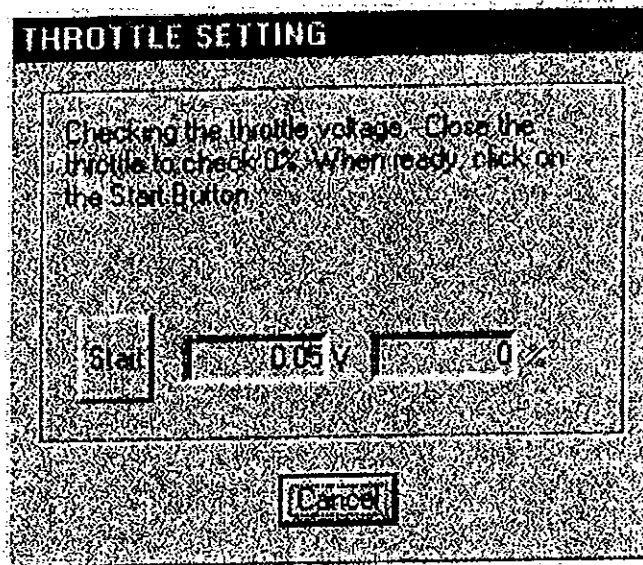

- After the Throttle Setting is complete, confirm that wide open throttle shows 100% and fully closed shows 0%. If not perform the setting again, or check the throttle signal wire.

### Important

- On the vehicle without throttle position sensor, or with only a throttle switch will not be able to set this and the related feature.

### Confirm settings

Once all of the settings in the Parameter Setting is complete, click on "Confirm" to send the data to the Main Unit. Then turn the IG key to "OFF" position.

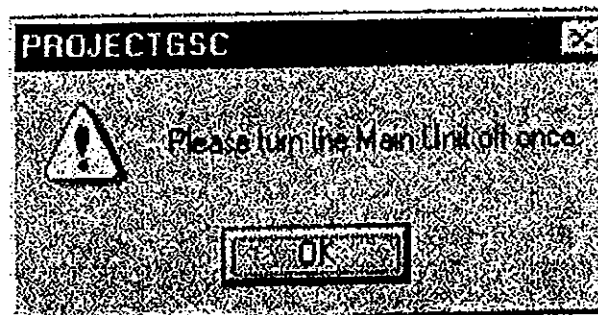

## 10. Programming Procedure

### Basic Programming procedure

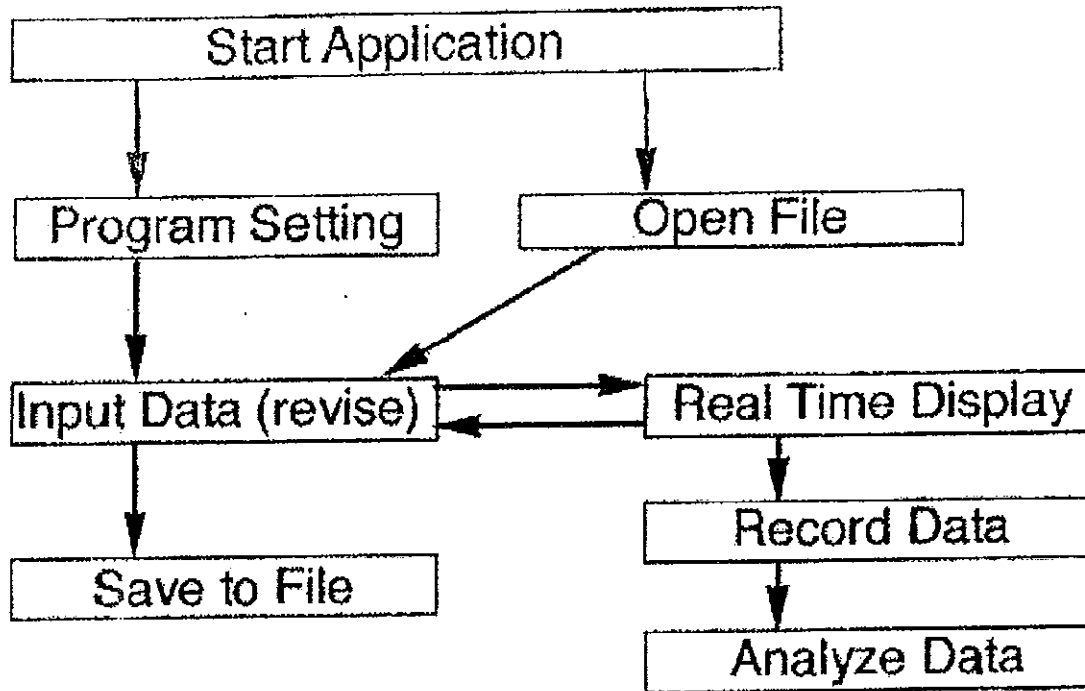

### Setting and Opening map table

- Open the desired map tables by selecting from the MAP SELECT pull down menu or click on the appropriate icons.

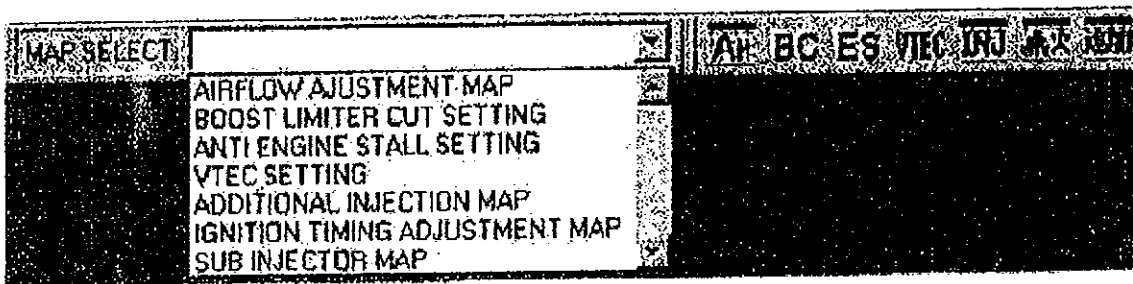

## 10. Programming Procedure

### Inputting values

- To input a value in a desired cell, click on the cell to high light it, then input a numerical value.
- To input the same value into a whole column(s) or row(s), click on the blue axis cell to high light the entire the column(s) or row(s).
- To input a value into a block of cells, high light the desired block of cells.
- By using "pg up" key, you can increase the input value in the selected cells.
- By using "pg dn" key, you can decrease the input value in the selected cells.
- Use the "undo" in the "Edit" pull down menu or icon to cancel the last change.
- If a improper value such as too large of a value was inputted, error message or the closest value will be inputted.



### Interpolate

- Use the "Interpolate" button to fill in the values between two cells, or four cells in the corners of a block.

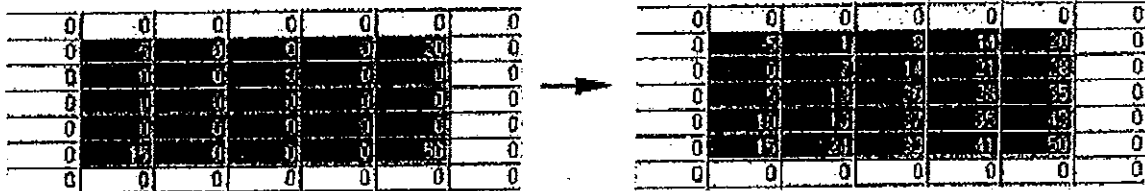

### Initial Programming (Map Clear)

- Select create new file from the menu and export it to the Main Unit. This will clear any program in the e-Manage. This cannot change the switch setting on the e-Manage.



- This feature can be used when the Main Unit is used on a different vehicle.

## 11. Set-up and Map Window Information

### BC Boost Limiter Cut Setting

- This is used to eliminate the factory fuel cut by ECU due to the increase of the intake air flow.
- The Air Flow Meter or MAP sensor input signal to the ECU can be clamped. However, since ECU can not recognize the amount of increase of the intake air flow over the clamped signal, compensation (increased fuel) in the Additional Injector Map is recommended.

(To set up)

1. In the data logging feature (Data Analysis), record the rpm point and air flow meter/MAP sensor voltage and injector duty cycle where the boost limit occurred.
2. Input the clamping value. Input a value slightly lower than the point where injector duty cycle becomes 0% in the data.

BOOST LIMITER CUT SETTING															Page 24
rpm	100rpm	Clamp Value (0.05V clamp)													
500	1000	1500	2000	2500	3000	3500	4000	4500	5000	5500	6000	6500	7000	7500	8000
5.00	5.00	5.00	5.00	5.00	5.00	5.00	5.00	5.00	5.00	5.00	5.00	5.00	5.00	5.00	5.00

rpm:

Input range: 0 ~ 10000rpm, 100rpm increments

Clamp Value: This will automatically change according to the sensor type.

Input range: 0 ~ 5V, 0.05V increments (Air Flow, or MAP type:V)

Input range: 0 ~ 3150Hz, 50Hz increments (Karman type :Hz)



Take it easy!

- This feature is not used for the vehicles that does not have a boost limiter.

## 11. Set-up and Map Window Information

### ES Anti Engine Stall Setting

- This feature is used to stabilize the rough idle due to the turbo compressor surge, blow-off valve vented out to the atmosphere or use of a high lift camshaft.
- Input the Throttle Position in degrees. This will allow the values below the inputted value (throttle opening) to be recognized as accelerator OFF (fully closed).
- The Airflow Meter or MAP sensor input signal to the ECU can be clamped at a desired voltage at 8 different rpm points to prevent engine stall or rough idle.

(To set up)

1. In the data logging feature (Data Analysis), record the rpm point, air flow meter/MAP sensor voltage and injector duty cycle where the engine stalls.
  2. Input the rpm points where the airflow voltage fluctuates and input the airflow clamping value.
- \* This feature will only work when a T.P. value is inputted.

ANTI ENGINE STALL SETTING								
Throttle Position (%) 1% increment - Accelerator OFF below the inputted value								
<input type="text" value="0"/>								
Clamp Value (V) 0.02 increment								
	500	600	700	800	900	1000	1200	1500
	0.00	0.00	0.00	0.00	0.00	0.00	0.00	0.00

Throttle Position: %

Input range : 0 ~ 10%, 1% increments

rpm:

Input range: 0 ~ 8000rpm, 50rpm increments

Clamp Value: This will automatically change according to the airflow type.

Input range: 0 ~ 5V, 0.05V increments (Air Flow, or MAP type:V)

Input range: 0 ~ 3150Hz, 50Hz increments (Karman type :Hz)



Take it easy!

- This feature is not needed for vehicles that do not have any engine stalling problems.

# 11. Set-up and Map Window Information

## VTEC Setting

- This is used to set the VTEC setting without going in to the Main Unit.
- The VTEC setting with the PC will over ride the setting on th Main Unit.
- VTEC Lo->Hi is the shift point under acceleration.
- VTEC Hi->Lo is the shift point under deceleration.
- When the VTEC shift point is changed from factory setting, the airflow will need to be adjusted for proper air/fuel ratio.
- When a shift point is set lower than factory, use ECU-Lo E/G-Hi to compensate for the Airflow difference.
- When a shift point is set higher than factory, use ECU-Hi E/G-Lo to compensate for the Airflow difference.

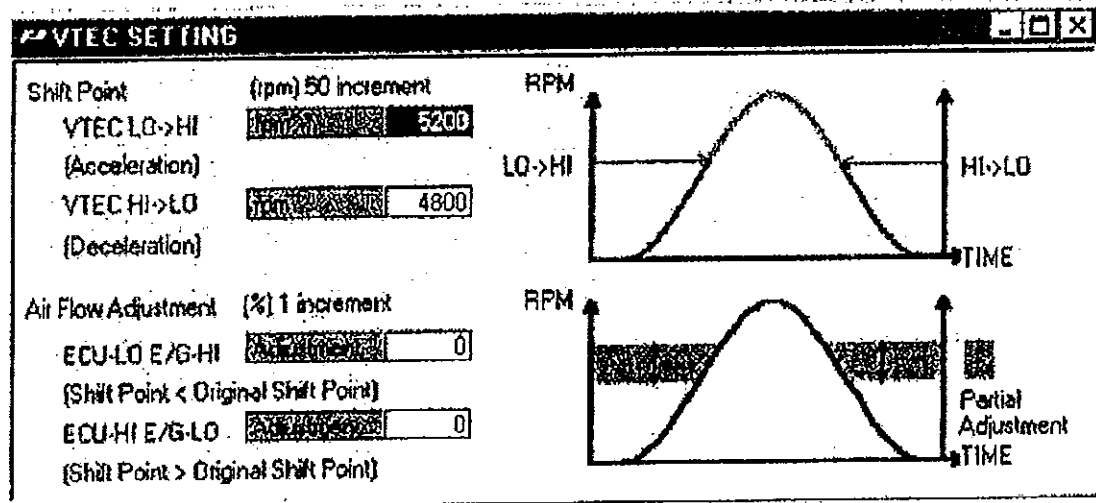

rpm:

Input range: 1500 ~ 7000rpm, 50rpm increments

Adjustment Value: %

Input range : -20 ~ +20%, 1% increments

Input range : 0 ~ 100%, 0.5% increments



## 11. Set-up and Map Window Information

### About scale in Map

Air Flow Adjustment Map  
Additional Injection Map  
Ignition Timing Adjustment MAP  
Sub-Injector MAP

- The value in the scale can be changed, by clicking the "Scale Change" button and inputting a value. After the change is made, click on the "Scale Change" to lock the value.
- Since this is a "piggy back" system, a "zero" value inputted in any map table will be same as the factory ECU setting, and any value other than "zero" is the adjustment to the factory ECU signals or program.

RPM axis: rpm

Input range: 0 ~ 10000rpm, 100rpm increments

Load axis: V, Hz, Absolute Pressure (kPa, kg/cm<sup>2</sup>, mmHg),

Relative Pressure (kPa, kg/cm<sup>2</sup>, mmHg)

Units will automatically change according to the airflow type.

Input range: 0 ~ 5V, 0.05V increments (Air Flow, or MAP type:V)

Input range: 0 ~ 3150Hz, 50Hz increments (Karman type :Hz)

Input range: 0 ~ 5V, 0.05V increments (GRReddy Pressure sensor:V)

### Please

- The pressure (kPa) displayed in the load axis scale is converted from the sensors voltage value, and kg/cm<sup>2</sup> and mmHg display is converted from kPa. When the scale is changed, the system will round off the last digit during the conversion, so to make the proper change, perform the scale change in the voltage scale.

# 11. Set-up and Map Window Information



## Air Flow Adjustment Setting

- This is used to adjust the input signal of the Air Flow Meter or MAP Sensor to the ECU for fuel enrichment.
- 16 points of rpm and throttle position is used for fine tuning.
- This setting will add to the Air-Flow Adjust Volume (A.A.V) RPM Setup on the main unit.
- Input a negative value to take away fuel.
- When programming the Air Flow Adjustment Map with the PC, it is recommended to set all of the Air Flow Adjust Volume (A.A.V) RPM Setup on the Main Unit to "ZERO".
- Since this is a "piggy back" system, a "zero" value inputted in any map table will be same as the factory ECU setting, and any value other than "zero" is the adjustment to the factory ECU signals or program.

Throttle Pos.	0	1	2	3	4	5	6	7	8	9	10	11	12	13	14	15	16
0	0	0	0	0	0	0	0	0	0	0	0	0	0	0	0	0	0
1	0	0	0	0	0	0	0	0	0	0	0	0	0	0	0	0	0
2	0	0	0	0	0	0	0	0	0	0	0	0	0	0	0	0	0
3	0	0	0	0	0	0	0	0	0	0	0	0	0	0	0	0	0
4	0	0	0	0	0	0	0	0	0	0	0	0	0	0	0	0	0
5	0	0	0	0	0	0	0	0	0	0	0	0	0	0	0	0	0
6	0	0	0	0	0	0	0	0	0	0	0	0	0	0	0	0	0
7	0	0	0	0	0	0	0	0	0	0	0	0	0	0	0	0	0
8	0	0	0	0	0	0	0	0	0	0	0	0	0	0	0	0	0
9	0	0	0	0	0	0	0	0	0	0	0	0	0	0	0	0	0
10	0	0	0	0	0	0	0	0	0	0	0	0	0	0	0	0	0
11	0	0	0	0	0	0	0	0	0	0	0	0	0	0	0	0	0
12	0	0	0	0	0	0	0	0	0	0	0	0	0	0	0	0	0
13	0	0	0	0	0	0	0	0	0	0	0	0	0	0	0	0	0
14	0	0	0	0	0	0	0	0	0	0	0	0	0	0	0	0	0
15	0	0	0	0	0	0	0	0	0	0	0	0	0	0	0	0	0
16	0	0	0	0	0	0	0	0	0	0	0	0	0	0	0	0	0

Adjustment Value: %  
 Input range : -50 ~ +50%, 0.5% increments

**Important**

- When a substantial adjustment is made, the ignition timing can be change as well. Make sure to check the air/fuel ratio with proper equipment to prevent any detonation.







## 12. About the Menu Bar

### [File]

File(F)	Edit(E)	Settings	V
New file(N)	Ctrl+N		
Open(O)	Ctrl+O		
Save(S)	Ctrl+S		
Save as(A)			
Print(P)	Ctrl+P		
Print setup(B)			
Exit(X)			

### [Edit]

Edit(E)	Settings	View	
Undo(U)	Ctrl+Z		
Redo(R)	Ctrl+Y		
Cut(I)	Ctrl+X		
Copy(C)	Ctrl+C		
Paste(P)	Ctrl+V		

### [Setting]

Settings	View(V)	Option(O)	Communication
Main Unit Setting Information(A)	Ctrl+A		
Parameter Setting(Q)	Ctrl+Q		
Security Setting			

Main Unit Setting Information	To display the Main Unit's Settings.
Parameter Setting	To display the Parameter Setting
Security Setting	To protect the data with a password.

## 12. About the Menu Bar

### [View]

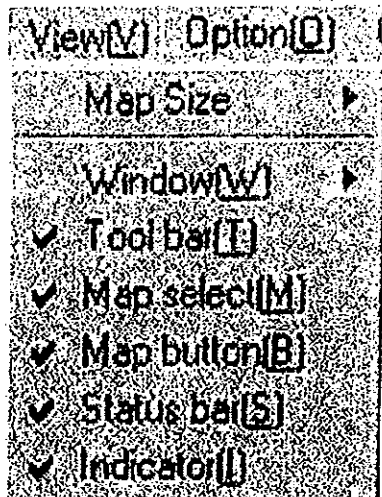

Map Size	Used to change the map size. (S, M, L and XL)
Window	Select to view the window tiled or cascade.
Tool bar	Used to show or hide the Tool bar.
Map select	Used to show or hide the MAP SELECT pull down menu.
Map button	Used to show or hide the Map icon buttons.
Status bar	Used to show or hide the Status bar.
Indicator	used to show or hide the Indicator.

### [Option]

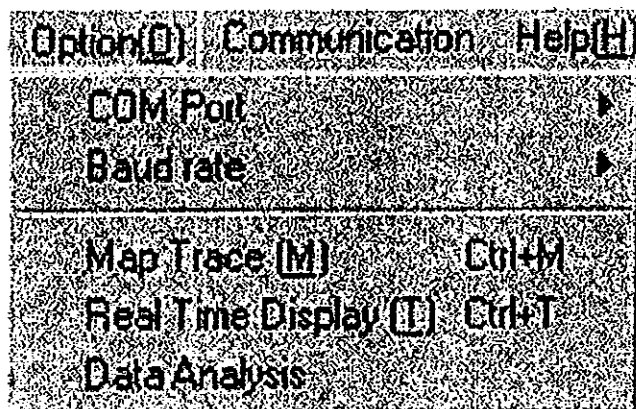

COM Port	Used to select the COM Port for communication cable.
Baud rate	Used to select the Baud rate.
Map Trace	Used to open the Map Trace display.
Real Time Display	Used to open the Real Time display.
Data Analysis	Used to open the Data Analysis display.

## 12. About the Menu Bar

### [Communication]

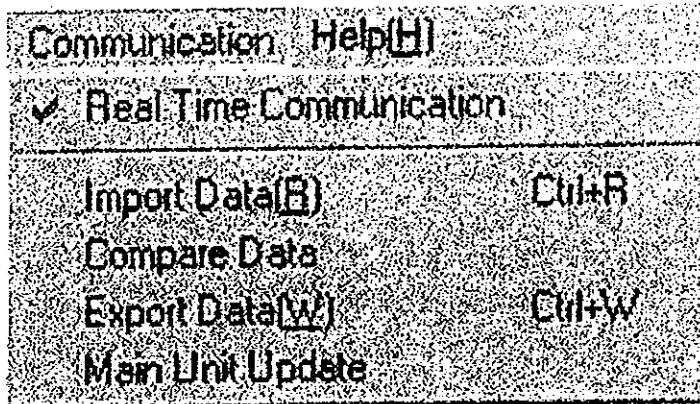

Real Time Communication	Used to start or end the real time communication.
Import Data	Used to import the data from the Main Unit. If a password is required to import data, password input window will pop up.
Compare Data	Used to compare the data on the PC and the Main Unit.
Export Data	Used to export all the data to the Main Unit.
Main Unit Update	Used to update the Main Unit Program.

### [Help]

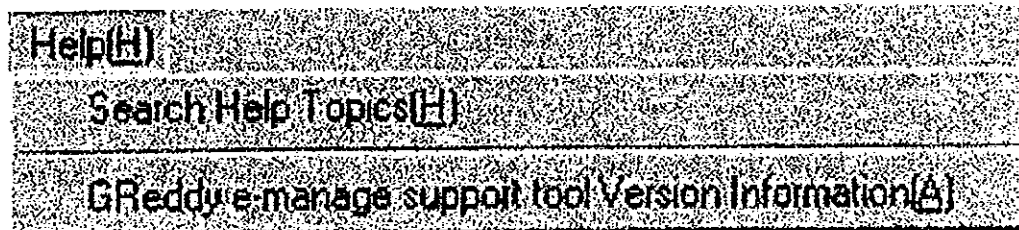

Search Help Topics	Used to search the help menu by topics.
GReddy a-Manage support tool Version Information	Used to show the current software and main unit program versions.



# 13. About the Tool Bar

## Tool Bar

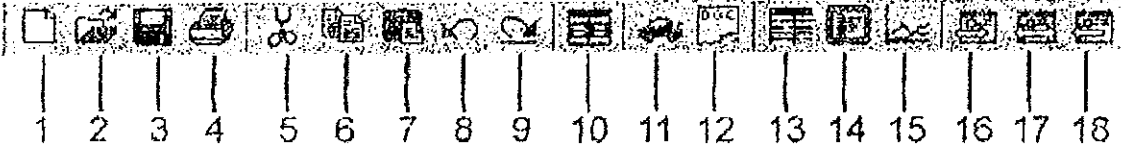

## Menu

- 1. New file
- 2. Open
- 3. Save
- 4. Print
- Edit - - - - - Page \_\_\_\_\_
- 5. Cut
- 6. Copy
- 7. Paste
- 8. Undo
- 9. Redo
- 10. Interpolate - - - - - Page \_\_\_\_\_
- Setting- - - - - Page \_\_\_\_\_
- 11. Parameter Setting - - - - - Page \_\_\_\_\_
- 12. Main Unit Setting Information - - - - - Page \_\_\_\_\_
- Option - - - - - Page \_\_\_\_\_
- 13. Map Trace Setting - - - - - Page \_\_\_\_\_
- 14. Real Time Display - - - - - Page \_\_\_\_\_
- 15. Data Analysis - - - - - Page \_\_\_\_\_
- Communication - - - - - Page \_\_\_\_\_
- 16. Import Data
- 17. Compare Data
- 18. Export Data

## About the Indicator

• The e-Manage mark on the top right of screen is a communication status indicator.



- OFF LINE - - - - - Yellow (solid)
- ON LINE - - - - - Green (solid)
- ON LINE Real Time Communication - - - Green (flash)
- ON LINE Recording Data - - - - - Red (solid)

## 14. Map Trace Feature



### Map Trace Feature

- This allows the tuner to pin point the current location on 16 x 16 map table.
- Select the "Map Trace" from the "Option" in the menu bar or click on the "Map Trace" icon.
- Once the Map Trace display is opened, the tracing will begin in the opened 16 x 16 map tables.
- This feature requires Real Time Communication.

0.0	0.0	0.0	0.0	0.0	0.0	0.0	0.0
9.0	9.0	6.5	6.5	6.0	5.5	5.0	4.0
11.5	13.0	11.5	11.5	13.5	12.5	12.0	11.5
21.5	20.5	26.5	31.5	23.5	22.5	22.0	16.5
26.5	25.5	31.5	35.5	28.5	27.5	29.5	26.5
31.5	28.0	31.5	40.5	33.5	32.5	32.0	29.0
34.0	33.0	36.5	43.0	39.5	37.5	37.0	31.0
46.5	40.5	41.5	48.0	41.0	42.5	42.0	36.5
50.0	43.0	44.0	48.0	46.0	45.0	44.5	38.5
54.0	45.5	49.0	49.0	46.0	45.0	44.5	39.5
59.0	50.5	59.0	59.0	48.5	50.0	49.5	42.0
61.5	60.5	59.0	59.0	53.5	52.5	54.5	44.5
64.0	60.5	59.0	59.0	56.0	55.0	54.5	48.5
64.0	60.5	59.0	59.0	56.0	55.0	54.5	48.5
64.0	60.5	59.0	59.0	56.0	55.0	54.5	48.5

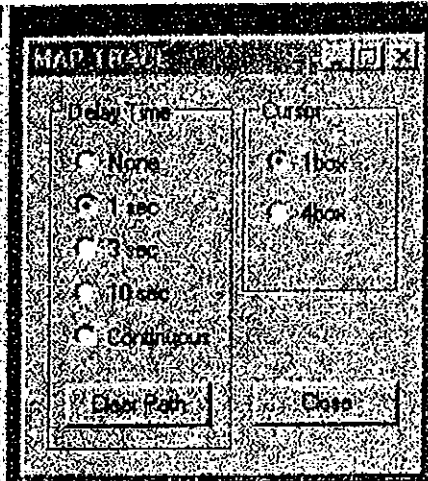

**Display Time:** The trace can be delayed by 1 sec, 3 sec, 10 sec or continuous for easy monitoring. When continuation is selected, it will display the trace path (trail) until the "clear path" is used.

**Cursor:** There are two selectable cursor sizes. (1box or 4 box)  
When "4 box" is selected the surrounding cell of the current value will be high lighted

### Important

- There is a possibility that the map trace will delay due to the PC's RAM size when multiple map table is opened and/or Real Time display is being used at the same time. In this case, open only one map table at a time.

## 15. Real Time Display Feature



### Real Time Display

- This allows the tuner to monitor all the signals coming in and out from e-Manage in real time.

REAL TIME-DISPLAY		
Record		
RPM	0	rpm
Airflow Meter Input	0.01	V
Airflow Meter Output	0.00	V
Normal Inj. Duty Cycle	0	%
Total Inj. Duty Cycle	0	%

Buttons: Display, Input Data Setup, Close

- Select the desired input data to be monitored from the Input Data Setup menu.

**INPUT DATA SETUP**

<input checked="" type="checkbox"/> RPM/min	<input type="checkbox"/> Normal Inj. Duration(msec)
<input type="checkbox"/> Total Airflow Ad.(%)	<input checked="" type="checkbox"/> Normal Inj. Duty Cycle(%)
<input type="checkbox"/> Inj. Pulse Position(%)	<input type="checkbox"/> Total Inj. Duration(msec)
<input checked="" type="checkbox"/> Airflow Meter Input 1(V)	<input checked="" type="checkbox"/> Total Inj. Duty Cycle(%)
<input type="checkbox"/> Airflow Meter Input 2(V)	<input type="checkbox"/> Add. Injection Time(msec)
<input checked="" type="checkbox"/> Airflow Meter Output(V)	<input type="checkbox"/> Add. Injection Rate(%)
<input type="checkbox"/> IP Feed Back(V)	<input type="checkbox"/> Sub Injector(msec)
<input type="checkbox"/> Relative Pressure(kPa)	<input type="checkbox"/> Sub Injector(%)
<input type="checkbox"/> Relative Pressure(kg/cm <sup>2</sup> )	<input type="checkbox"/> Ignition Timing Adj. (deg)
<input type="checkbox"/> Relative Pressure(mmHg)	<input type="checkbox"/> VTEC Signal Input
<input type="checkbox"/> Pressure Sensor Input(V)	<input type="checkbox"/> VTEC Signal Output
<input type="checkbox"/> Absolute Pressure(kPa)	
<input type="checkbox"/> Absolute Pressure(kg/cm <sup>2</sup> )	
<input type="checkbox"/> Absolute Pressure(mmHg)	

Buttons: OK, Cancel

## 15. Real Time Display Feature

### Graph Display

- Click on the "Graph" button to display the graph.
- Click on the "Reset" button to clear the graph.
- Double click on input data to adjust max. and min. of each scale.
- Double click on the color box to change the line color.
- By pressing "RECORD" the selected input data will begin to record.
- The recorded data can be saved on disk.

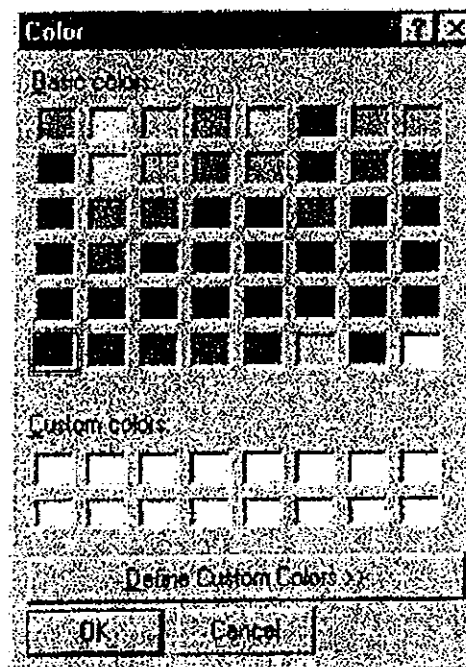
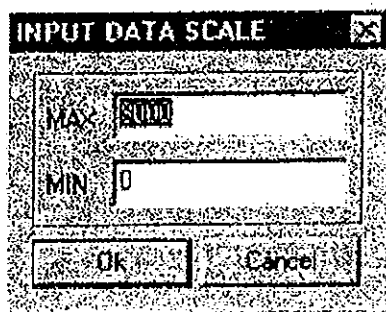
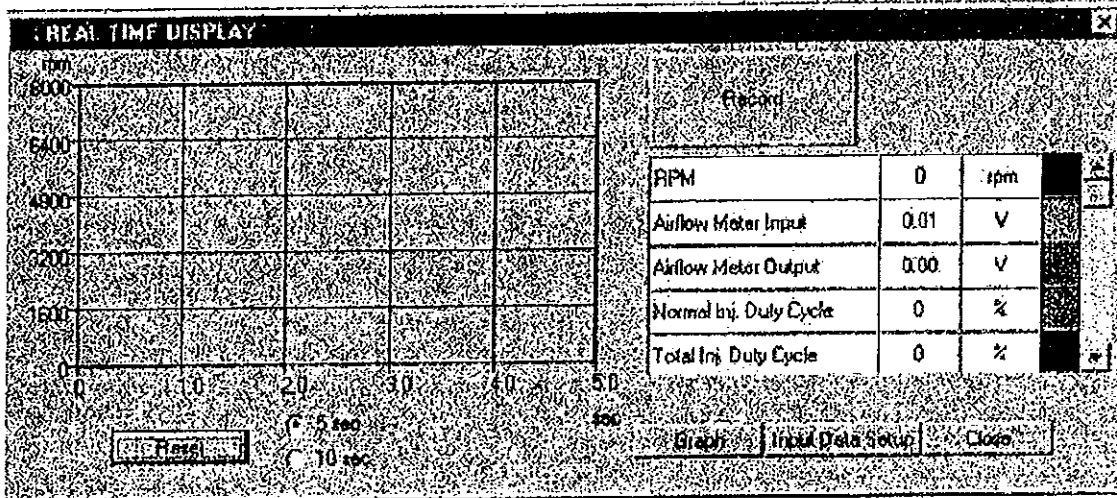

## 15. Real Time Display Feature

### Record Data



- **Record Button:**  
Click on this button to start recording the data.



- **Stop Button:**  
Click on this button to stop recording.



- **Save Data Button:**  
The recorded data can be saved on disk.



- The recorded and saved data can be opened in the Data Analysis Feature.

## 16. Data Analysis Feature



### Data Analysis

- This allows the tuner to monitor all the signals coming in and out from e-Manage in real time.

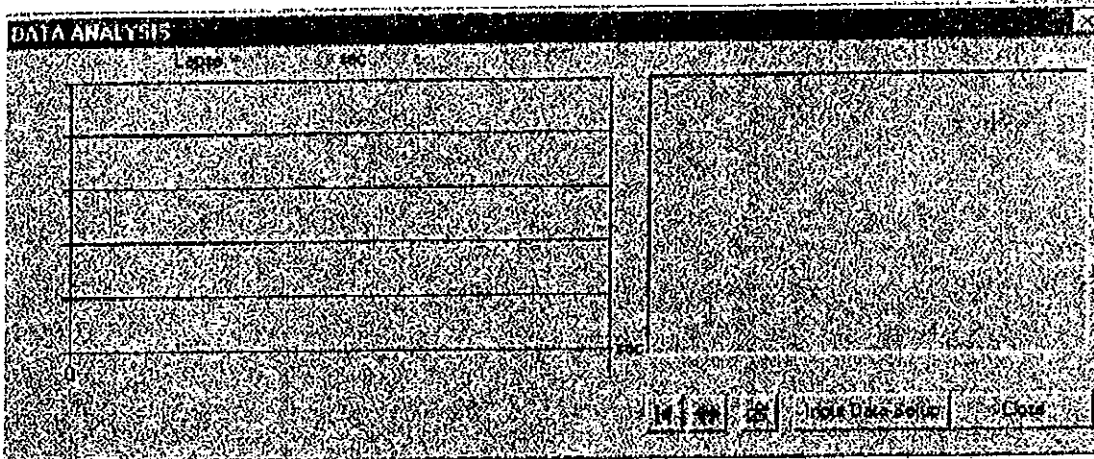

Open File button: Click on this button to open the saved file from Real Time Monitor Feature

### Input Data Setup

- Select the desired input data to be monitored from the Input Data Setup menu.
- Double click on the color box to change the line color.

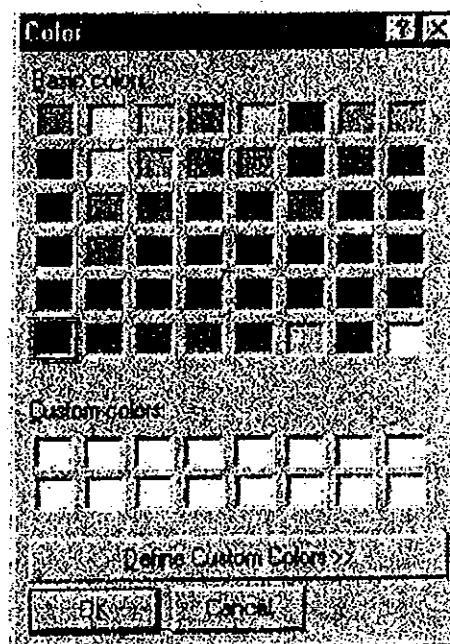

## 16. Data Analysis Feature

- Double click on input data to adjust max. and min. of each scale.

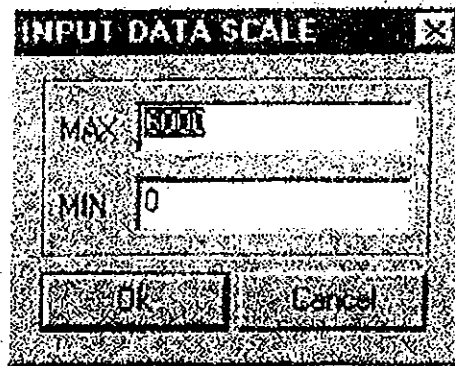

- Double click on each measurement to view the max. and min. values recorded in each category.

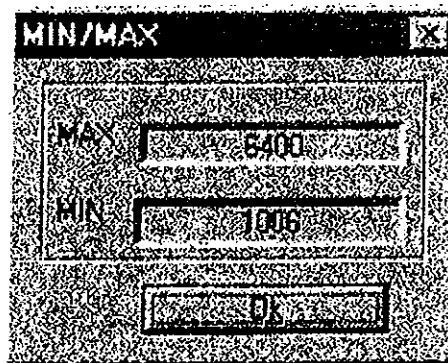

- Click to highlight each of the input data in the table too show the scale of each data.
- Using the mouse, click on graph to see the input values at that point.



- Highlight a section on the graph and click on the "zoom" button to zoom in to the selected sections.



- Click on the "Back" button to return to the previous graph size.

## 17. Security Feature

### Security Setting

- This allows the tuner set up password to apply security lock to the data in the main unit.
- It will require the tuner to input a password to communicate with the main unit.

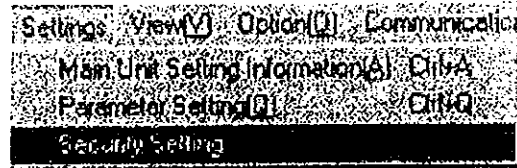

- To Lock - - - - Click on the "Security Setting" in the "Setting" menu. Input the password and click "OK".
- To Unlock - - - - Input the password. Open the "Security Setting" and click "OK" without inputting any password.



- It is used to lock the data for confidentiality.

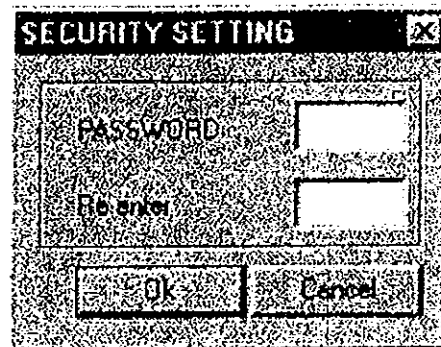

### Map Clear

- It is possible to erase and overwrite all the data that is locked by clicking the Map Clear button.
- To Clear the program, click on "Clear Map" in the Password input window.

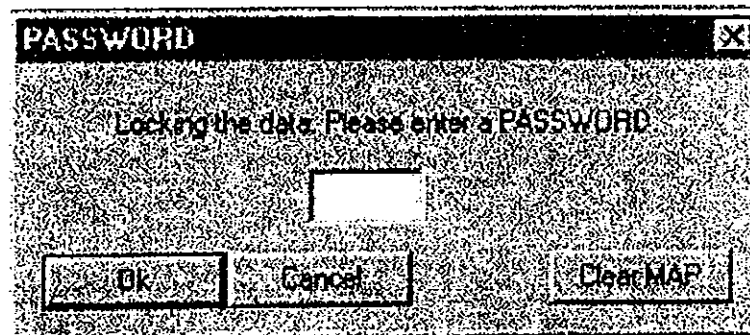



## 18. Error Code Chart

### How to read the error codes

Count the red flashes on the e-Manage unit to check the code(s).  
It's very similar to checking factory ECU codes.

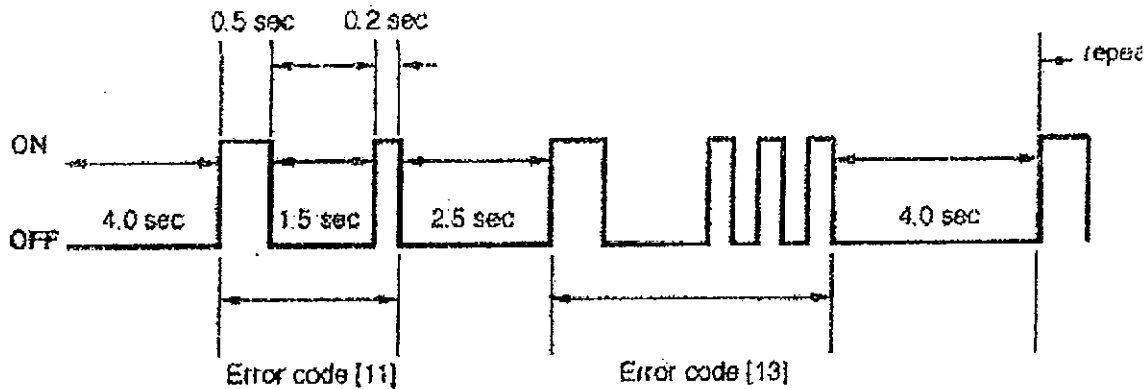

### Error Codes Chart

CODE	Error	Error description
11	Airflow Signal 1 input error	Incorrect wiring or disconnected Airflow Signal 1
12	Airflow Signal 2 input error	Incorrect wiring or disconnected Airflow Signal 2. Incorrect Jumper setting (JP3).
13	Karman Vortex sensor input error	Incorrect wiring or disconnected Karman Signal. Incorrect Jumper setting (JP4).
14	VTEC Signal input error	Incorrect VTEC signal input wiring. Incorrect Jumper setting (JP4).
15	Airflow voltage output error	Incorrect Airflow signal output wiring.
16	VTEC Signal output error	Incorrect VTEC signal output wiring. Incorrect Jumper setting (JP3).
20	No injector pulse from all	Not receiving an injector signal for Additional Injection Map
21	No injector 1 pulse	Not receiving injector signal I/J CH-1 for Additional Injection Map
22	No injector 2 pulse	Not receiving injector signal I/J CH-2 for Additional Injection Map
23	No injector 3 pulse	Not receiving injector signal I/J CH-3 for Additional Injection Map
24	No injector 4 pulse	Not receiving injector signal I/J CH-4 for Additional Injection Map
25	No injector 5 pulse	Not receiving injector signal I/J CH-5 for Additional Injection Map
26	No injector 6 pulse	Not receiving injector signal I/J CH-6 for Additional Injection Map
27	No injector A pulse	Not receiving injector signal I/J CH-A for Additional Injection Map
28	No injector B pulse	Not receiving injector signal I/J CH-B for Additional Injection Map

## 18. Error Code Chart

CODE	Error	Error description
31	Incorrect injector 1 pulse	Incorrect I/J CH-1 wire to e-Manager unit
32	Incorrect injector 2 pulse	Incorrect I/J CH-2 wire to e-Manager unit
33	Incorrect injector 3 pulse	Incorrect I/J CH-3 wire to e-Manager unit
34	Incorrect injector 4 pulse	Incorrect I/J CH-4 wire to e-Manager unit
35	Incorrect injector 5 pulse	Incorrect I/J CH-5 wire to e-Manager unit
36	Incorrect injector 6 pulse	Incorrect I/J CH-6 wire to e-Manager unit
37	Incorrect injector A pulse	Incorrect I/J CH-A wire to e-Manager unit
38	Incorrect injector B pulse	Incorrect I/J CH-B wire to e-Manager unit
40	Improper order of ignition input signal	Incorrect wiring order of the ignition signal wires.
41	No Ignition Signal 1 pulse	Not receiving the ignition signal to IG CH-1
42	No Ignition Signal 2 pulse	Not receiving the ignition signal to IG CH-2
43	No Ignition Signal 3 pulse	Not receiving the ignition signal to IG CH-3
44	No Ignition Signal 4 pulse	Not receiving the ignition signal to IG CH-4
45	No Ignition Signal 5 pulse	Not receiving the ignition signal to IG CH-5
46	No Ignition Signal 6 pulse	Not receiving the ignition signal to IG CH-6
47	JP1 PULL UP error	Incorrect Jumper setting (JP1)
48	JP1 PULL DOWN error	Incorrect Jumper setting (JP1)
49	No Ignition pulse	Not receiving the ignition signal to any of the channels
51	Incorrect Ignition 1 pulse	Incorrect IG CH-1 wire to e-Manager unit
52	Incorrect Ignition 2 pulse	Incorrect IG CH-2 wire to e-Manager unit
53	Incorrect Ignition 3 pulse	Incorrect IG CH-3 wire to e-Manager unit
54	Incorrect Ignition 4 pulse	Incorrect IG CH-4 wire to e-Manager unit
55	Incorrect Ignition 5 pulse	Incorrect IG CH-5 wire to e-Manager unit
56	Incorrect Ignition 6 pulse	Incorrect IG CH-6 wire to e-Manager unit
57	JP2 + 12V error	Incorrect Jumper setting (JP2)

# 19. ECU Wire Location Chart

# TOYOTA

## TOYOTA

Model	Chassis Code	Year	Engine Code	Sensor Type	Switch setting			CPU#	ECU Location
					1	2	3		
Supra	JZA80	93.5~97.7	2JZ-GTE	TY_PR-1	7	4	0	T-15	5
Celica	ST205	94.2~99.7	3S-GTE	TY_PR-2	2	4	1	T-2	2
MR-2	SW20	93.10~99.7	3S-GTE	TY_PR-2	2	4	1	T-2	10
		89.10~93.9		TY_FL-2	2	4	8		
	AW11	86.8~89.9	4A-GZE	TY_FL-4	2	4	A		
		84.6~89.9	4A-GE	TY_PR-3	2	4	2	T-3	
Corolla	AE86	83.5~87.4	4A-GE	TY_PR-3	2	4	2	T-3	4

Sensor Type    TY\_HW: TOYOTA Hotwire Type  
                   TY\_PR: TOYOTA Pressure Sensor  
                   TY\_FL: TOYOTA Flap Type

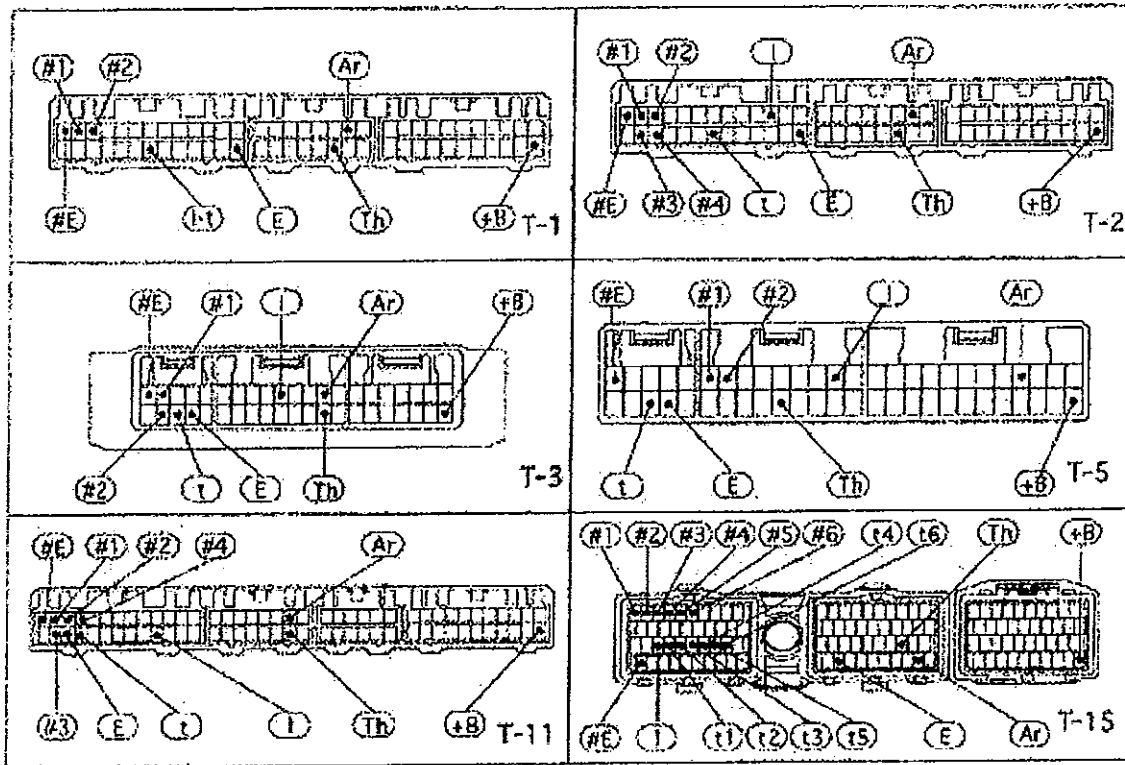

- +B: ← Power
- E: ← Ground
- I: ← RPM Signal
- Th: ← Throttle Signal
- Ar: ← Airflow/Pressure signal
- VT: ← VTEC Signal
- VM: ← VTM Signal
- #E: ← Injector Ground
- #\*: ← NO. # Injector Signal
- (I)\*: ← NO. # Ignition Signal
- (I.t): ← RPM & Ignition Signal
- (I)\*: ← NO. # & NO. # Ignition Signal
- (I.t)\*: ← Leading Ignition Signal
- (I.t)\*: ← NO. # Trailing Ignition Signal
- #P\*: ← NO. # Primary Injector Signal
- #S\*: ← NO. # Secondary Injector Signal

# 19. ECU Wire Location Chart HONDA

HONDA/ACURA

Model	Chassis Code	Year	Engine Code	Sensor Type	Switch setting			CPU#	ECU Location
					1	2	3		
Civic	EM1 (si)	99 - 00	B16A	HN_PR-1	2	8	A	H-1	4
	EJ6	96 - 00	D16Y					H-2	
	EJ7							H-2	
	EJ8							H-2	
	EJ1							H-3	
	EH3	92 - 95	D16Z					H-3	
EG9	H-3								
Integra	DC2/DB8	96 - 01	B18C	HN_PR-1	2	8	A	H-2	4
		94 - 95	B18C(M/T)					H-3	
Prelude	BB6/BB8	97 - 01	H22A	HN_PR-1	2	8	A	H-2	5
Accord	CF4	97.9~	F20B	HN_PR-1	2	8	A	H-1	5
	CD5		F22B					H-3	

Sensor Type HN\_PR: HONDA Pressure Sensor

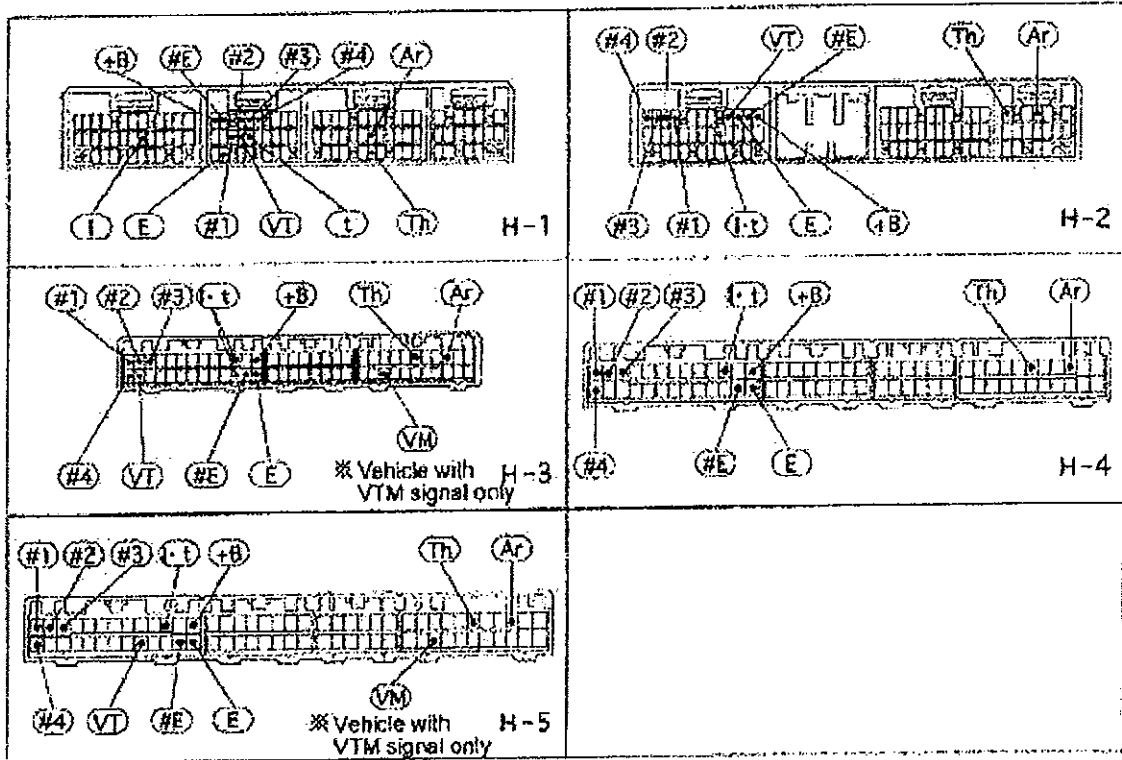

# 19. ECU Wire Location Chart NISSAN

NISSAN									
Model	Chassis Code	Year	Engine Code	Sensor Type	Switch setting			CPU #	ECU Location
					1	2	3		
300ZX	Z32	90~95	VG30DETT VG30DE	NS_JIW-2	7	0	1	N-3	5
SKYLINE	BNR34	89.1~	RB26DETT	NS_HW-6	7	0	5	N-4	4
	ECR33	95.1~98.12	RB26DETT	NS_HW-6	7	0	5	N-4	
	ECR33	95.1~98.4	RB25DEI	NS_HW-5	7	0	4	N-6	
				NS_HW-3	7	0	2		
	BNR32	89.8~94.12	RB26DETT	NS_HW-6	7	0	5	N-4	
HCR32	89.5~93.7	RB20DET	NS_HW-3	7	0	2	N-5		
240SX	S14	95~98	KAZ1DE	NS_HW-7	2	0	6	N-10B	4

Sensor Type NS\_HW: NISSAN Hotwire Type

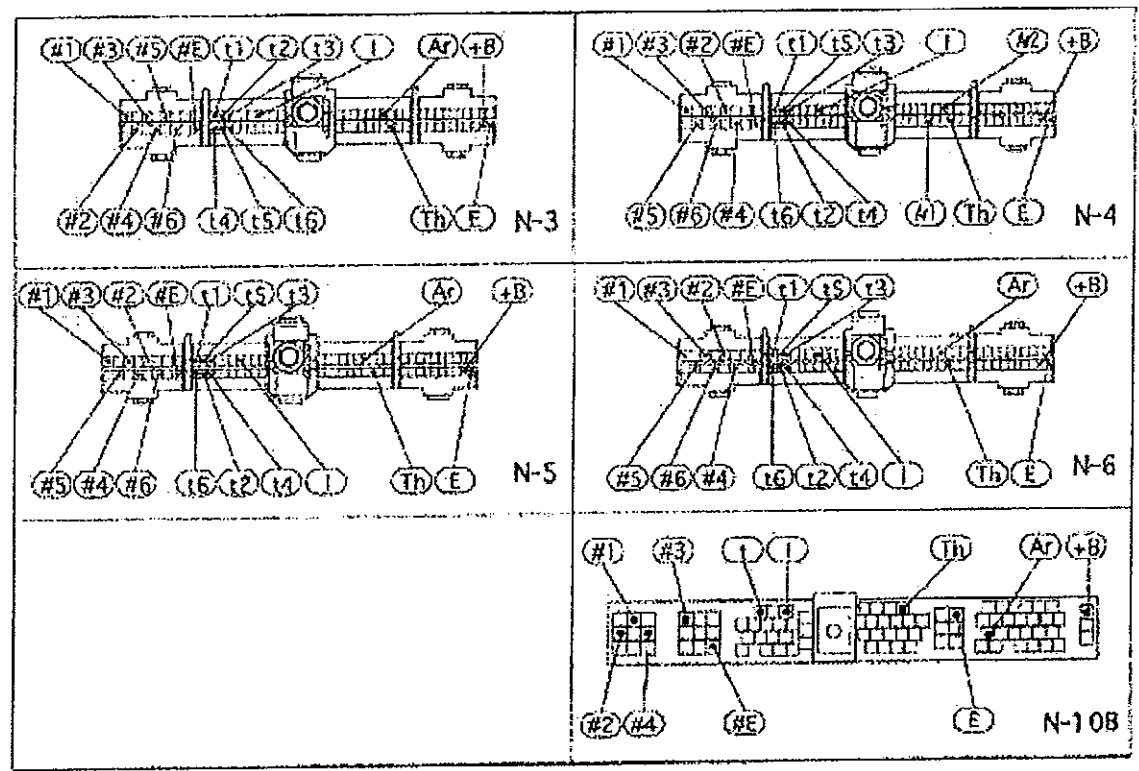

# 19. ECU Wire Location Chart

# MITSUBISHI

MITSUBISHI

Model	Chassis Code	Year	Engine Code	Sensor Type	Switch setting			CPU #	ECU Location
					1	2	3		
3000GT	Z16A	90-99	6G72	MT_KR-2	6	8	4	M-1	2
Eclipse	D32/D33	95-99	4G63	MT_KR-1	3	8	3	M-5	4
	D22/D27	98-94	M-2						

Sensor Type MT\_KR: MITSUBISHI Karman Vortex Type

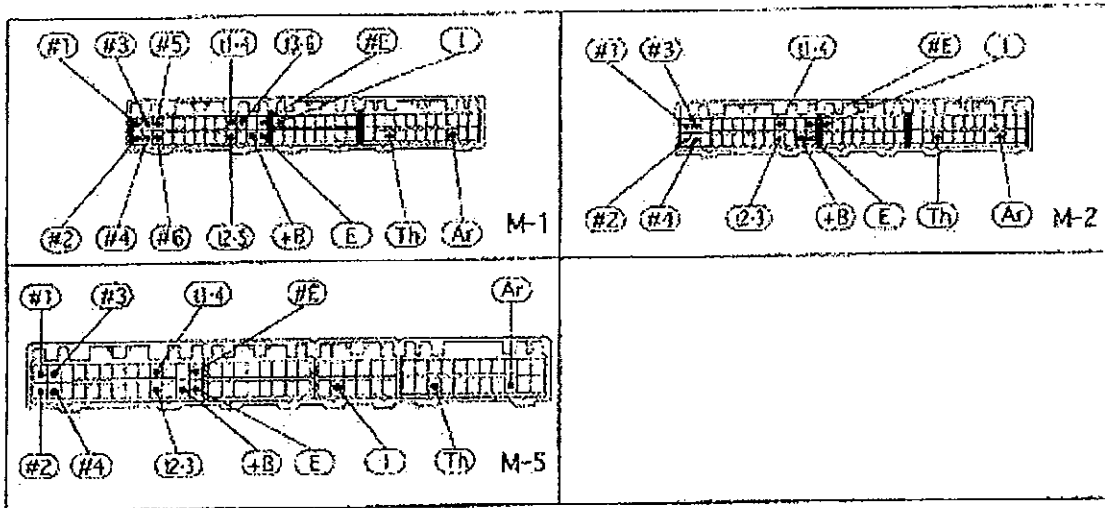

- +B ← Power
- E ← Ground
- I ← RPM Signal
- Th ← Throttle Signal
- Ar ← Airflow/Pressure signal
- VT ← VTEC Signal
- VM ← VTM Signal
- #E ← Injector Ground
- #\* ← NO. \* Injector Signal
- #\* ← NO. \* Ignition Signal
- I\* ← RPM & Ignition Signal
- #\* ← NO. \* & NO. \* Ignition Signal
- TL ← Leading Ignition Signal
- TT\* ← NO. \* Trailing Ignition Signal
- #P\* ← NO. \* Primary Injector Signal
- #S\* ← NO. \* Secondary Injector Signal

# 19. ECU Wire Location Chart MAZDA

MAZDA

Model	Chassis Code	Year	Engine Code	Sensor Type	Switch setting			CPU #	ECU Location
					1	2	3		
RX-7	FD3S	93~96						MA-3	4
	FC3S	89~92	13B	MZ_FL-2	B	A	A	MA-6	5
MIATA	NB6C ※	98.1~00.6	BP-2E	MZ_HW-1	3	A	0	MA-5	5
	NB6C	98.1~	BP-2E						
	NAGCE	89.9~93.7		MZ_FL-1	3	A	C	MA-7	

※ Adapter required (Japanese spec only)

Sensor Type    MZ\_HW: MAZDA Hotwire Type  
 MZ\_PR: MAZDA Pressure Sensor  
 MZ\_FL: MAZDA Flap Type

